

HOME DESIGN GUIDELINES

RIV  RTON

J I M B O O M B A



Contents

1.0 Riverton Home Design Guidelines	2	6.0 Fencing and Gates	14	11.1 Design and Planning Considerations.....	22
2.0 Why have Design Guidelines?	3	6.1 Secondary street frontage fencing	15	11.2 Retaining walls.....	23
2.1 Design Approval Process.....	4	7.0 Other Elements of Your Home	16	11.3 Native Planting	24
2.2 Non-Conforming Designs	4	7.1 Letterboxes	16	12.0 Services at Riverton	25
2.3 Obtaining Design Approval.....	5	7.2 Garages.....	16	13.0 Construction Guidelines	25
2.4 Approval Advice.....	5	7.3 Entry doors.....	16	13.1 Site Access	25
2.5 Construction Timelines	5	7.4 Curtains, Blinds and security screens	17	13.2 Hours of Construction.....	25
2.6 The ‘Design Approval’ Step by Step Process	6	7.5 Overhangs, Decks, Awnings & Eaves	17	13.3 Storage of Materials	26
2.7 Design Guidelines Compliance.....	7	7.6 Roofs	17	13.4 Rubbish	26
3.0 Locating your home on your lot	9	7.7 Gutters and Downpipes	17	13.5 Site Clean Up	26
3.1 Site Coverage and Setbacks	9	7.8 Pools.....	17	13.6 Noise	26
3.2 Private Open Spaces	10	7.9 Display.....	17	13.7 Temporary Amenities.....	26
3.3 Built to boundary walls.....	10	8.0 Ancillary Fixtures	18	13.8 Workplace Health & Safety.....	26
3.4 Building Heights	10	9.0 Secondary Dwellings and Dual Occupancies	19	13.9 Maintenance of Allotments and Verge.....	27
3.5 Floor Levels.....	10	9.1 Secondary Dwelling.....	19	13.10 Tenants	27
3.6 Bushfire Management.....	10	9.2 Dual Occupancy	19	13.11 Vehicles.....	27
4.0 Building Appearance	11	10.0 Sustainable Design	20	14.0 Disclaimer	29
4.1 Pleasing Home Designs	11	10.1 Energy Efficiency.....	20	15.0 Application Checklist	30
4.2 Building Materials and Colours	12	10.2 Orientating your home	21	Drawings Checklist.....	30
4.3 Corner allotments	12	10.3 Water Efficiency.....	21	16.0 Building Covenant Application Form	32
5.0 Car Parking, Garages & Driveways	13	10.4 Recycling and Waste Management.....	21	Important Information	32
5.1 Car Parking.....	13	10.5 Creating Healthy Homes.....	21	17.0 Landscape Planting Palette	33
5.2 Vehicle Crossovers.....	13	11.0 Landscaping, Gardens and Yards	22		
5.3 Driveways.....	13				

1.0 Riverton Home Design Guidelines

We want Riverton to be a community you'll love being part of.

A community with homes that complement each other and their surrounding environment.

Our vision is to create a community with homes that are modern yet reference the rural heritage of the Jimboomba area by incorporating design elements, materials, colours and landscaping that is typically associated with Queensland country homes.

These Design Guidelines will assist you in creating your home at Riverton to meet this vision and will help ensure that your home and your neighbours' homes all complement one another. The Guidelines set a standard for home and garden design and encourage the use of sustainable design features.

We've worked with architects, designers and builders to put together Guidelines for homes that reflect current home design and building trends but that have timeless appeal.

The Guidelines will help you design a home that:

- Feels spacious and comfortable inside and out
- Looks its best from the outside and maintains its appearance for many years
- Adds value to your property by providing landscaped gardens and yards
- Is cool in summer and warm in winter
- Makes the most of its location at Riverton
- Suits the Queensland climate and laid back lifestyle



IMAGE COURTESY OF PLANBUILD HOMES

2.0 Why have Design Guidelines?

Design Guidelines aim to set a standard for homes at Riverton to provide residents with an aesthetically pleasing environment that will protect your lifestyle now and into the future.

The Design Guidelines prescribe specific requirements for housing design, materials and finishes.

NOTE: These Guidelines form part of your Land Sales Contract.

The Design Guidelines aim to:

- Ensure that the unique character of Riverton is protected
- Encourage a diverse, contemporary and harmonious range of homes and landscapes
- Promote the use of sustainable building features
- Encourage the creation of homes that are in harmony with each other but not identical to each other
- Provide a high level of presentation to the neighbourhood

The Design Guidelines include things such as:

- Guidelines for external materials and colours
- Standards for fencing, driveways and landscapes
- A guide to understanding the covenant approval process
- Timeframes in which you need to complete building your home



IMAGES COURTESY OF GJ GARDNER HOMES

2.1 Design Approval Process

The 'Riverton Design Review Committee' (RDRC) is responsible for ensuring the homes built at Riverton meet these Guidelines. You will need to submit your plans to the RDRC and seek approval for them prior to building your home.

Email: rivertondesign@avjennings.com.au

This includes seeking approval for all associated elements of your home such as the garage, fence and any other structures. It is also mandatory that you seek approval from the RDRC before you seek Building Approval from Logan City Council or a Private Certifier.

When choosing a home design you might choose to use one of the approved designs from one of our partner builders. Riverton has a number of builders who have already sought design approval for the home designs they can create for you at Riverton.

Alternatively, you might submit your own design or that of your builder / architect to the RDRC for review and approval.

2.2 Non-Conforming Designs

These Design Guidelines encourage a standard and style of home at Riverton. The RDRC understands however that you may have a different vision for your home. The RDRC appreciates individuality and innovation in design and reserves the right to approve designs which may not meet the requirements of the Riverton Home Design Guidelines but which are considered by the RDRC to be of outstanding merit.

It is suggested that a concept sketch be lodged with the RDRC prior to working drawings being prepared to seek feedback on designs that do not conform.

Where your exterior colour selections vary from the Guidelines, please supply colour samples for the RDRC to assess.



IMAGE COURTESY OF METRICON HOMES



2.3 Obtaining Design Approval

In order for the RDRC to assess your design, please supply the information as detailed in Section 15 of this document. The application form is included at the back of this document as well as more information on the detail to provide.

2.4 Approval Advice

The RDRC will provide approval or otherwise of the working drawings within 15 days of their receipt. If amendments are required to ensure the home fits within the Guidelines you may need to resubmit some drawings. The RDRC will then provide approval or otherwise within 10 days of receiving the amendments.

2.5 Construction Timelines

The timing of construction within the Riverton community is important. Construction of your home must commence within 12 months from the date of settlement of the sale of the lot to the original buyer and you must not occupy your home until the home is complete.

Your home should be complete and habitable within 9 months of the construction start date. Completion of your home includes all fencing, driveway and window furnishings to windows visible from the street along with a Certificate of Classification being issued by Logan City Council or your Certifier. Landscape to be complete within 3 months of completion of your home.



2.6 The 'Design Approval' Step by Step Process

The steps involved to obtain design approval for your home.

STEP 1

1. Purchase land
2. Start planning by researching the location of services
3. Refer to the POD and these Guidelines
4. Start the design process with chosen builder / designer

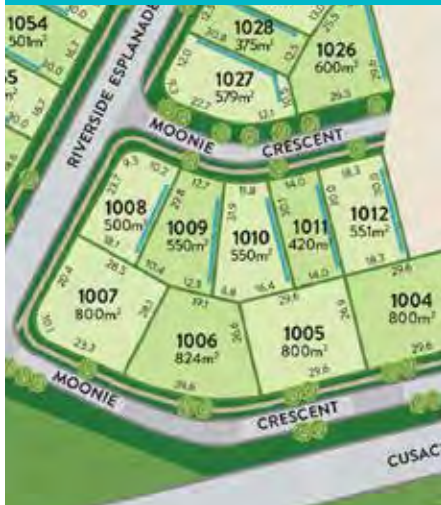

STEP 2

1. Ensure documents meet with the requirements of the POD, the Design Guidelines and application checklist
2. Prepare documentation for submission to the Riverton Design Review Committee (RDRC)
Email: rivertondesign@avjennings.com.au
3. The RDRC will assess the documentation against the Design Guidelines and advise of any additional information required
4. If your design is not approved you will need to amend it to comply with the requirements of the RDRC

STEP 3

1. If the requirements of the RDRC are met, an approval will be issued
2. Provide the RDRC approval to your builder for them to apply for the building approval



STEP 4

1. Building approval issued from Council
2. Once settlement has occurred, owners are responsible for rubbish and waste produced as part of their building process
3. Construction of the approved plan to commence within 12 months of settlement of the land from the Seller to the original buyer Construction to be completed within 9 months from the start date including fencing and window furnishings
4. Landscaping to be completed within 3 months of completion of your home
5. The new home will be inspected by the RDRC during or after completion to ensure its compliance with the approved drawings

2.7 Design Guidelines Compliance

Severance

Any void, voidable or illegal term of these Design Guidelines may be severed unless to do so will result in a change to the basic nature of these Design Guidelines.

Owner Bound by Design Guidelines

The owner acknowledges that these Design Guidelines will form a legal and binding part of the contract for the lot.

The owner and Seller agree that the terms of these Design Guidelines will not merge on settlement of the contract.

Right to Vary Design Guidelines

The Seller reserves its rights in any other sale and from time to time to vary the Design Guidelines contained herein and in that event, the owner will have no claim whatsoever against the Seller.

The Seller may in its absolute discretion vary or exclude any of these Design Guidelines from any contract for the sale of any lots in Riverton.

Compliance with Design Guidelines generally

The owner:

- (a) acknowledges that the Seller has a significant investment in Riverton, and has an interest in maintaining the value and desirability of lots within Riverton;
- (b) acknowledges that a failure by the owner to strictly comply with the Design Guidelines will diminish the value of the Seller's significant investment in Riverton;
- (c) acknowledges that a failure by the owner to strictly comply with the Design Guidelines will diminish the value and desirability of:
 - (i) unsold lots in Riverton in the hands of the Seller; and
 - (ii) lots sold by the Seller to other owners within Riverton.
- (d) agrees that in the event that the owner does not strictly comply with the Design Guidelines, the Seller will have legally enforceable rights against the owner, including the right to seek orders from the Courts compelling compliance by the owner, the right to enter onto the lot to undertake works to remedy a non-compliance and/or the right to seek damages against the owner; and
- (e) hereby irrevocably grants to the Seller or the Seller's representative or agent, a licence to enter onto the lot to undertake work reasonably necessary to rectify any non-compliance with the Design Guidelines, such right not to be exercised until after notice has been given by the Seller to the Design Guidelines to rectify the breach and that breach has not been rectified within the period provided for in the notice.

The owner warrants and represents to the Seller that the owner will comply strictly with the terms of the Design Guidelines and that it has the capacity to do so and the owner acknowledges that the Seller has relied on and been induced by those warranties and representations, to enter into the contract with the owner to sell the lot or consent to the sale of the lot to the owner. The owner (if more than one person) agrees that they are jointly and severally liable in relation to the obligations pursuant to these Design Guidelines.



3.0 Locating your home on your lot

The first thing you need to do when planning your home is to decide where best to locate it on your lot. When doing this, you need to refer to the table on the Plan of Development (POD) and the relevant setbacks required from the boundary lines.

NOTE: Where there is a conflict between these Guidelines and the POD, the POD prevails.

Site planning should also consider:

- Location of optional built to boundary walls. Consider if you would like to build up to the boundary of your property and if so, where the boundary wall can be located.
- Location of services and any easements on your lot and in the road such as for electricity, water, sewer and interallotment drainage, street lights, NBN Pits, SW Pits and manholes
- Orientation (refer to diagram on page 20) to maximise environmental benefits. Good orientation assists in passive heating and cooling, resulting in improved comfort and decreased energy bills. (Refer to clause 10.2)
- Eaves, awnings, hoods, screens and projected architectural elements that may extend a maximum of 1m into the setbacks or to a minimum of 450mm from the boundary.
- Disclosure plan and service plan provided by developer.

3.1 Site Coverage and Setbacks

There is a maximum site coverage set for Riverton to ensure that homes include outdoor spaces. Refer to the table on the Plan of Development relevant to your lot to find out the site coverage and setbacks that apply.

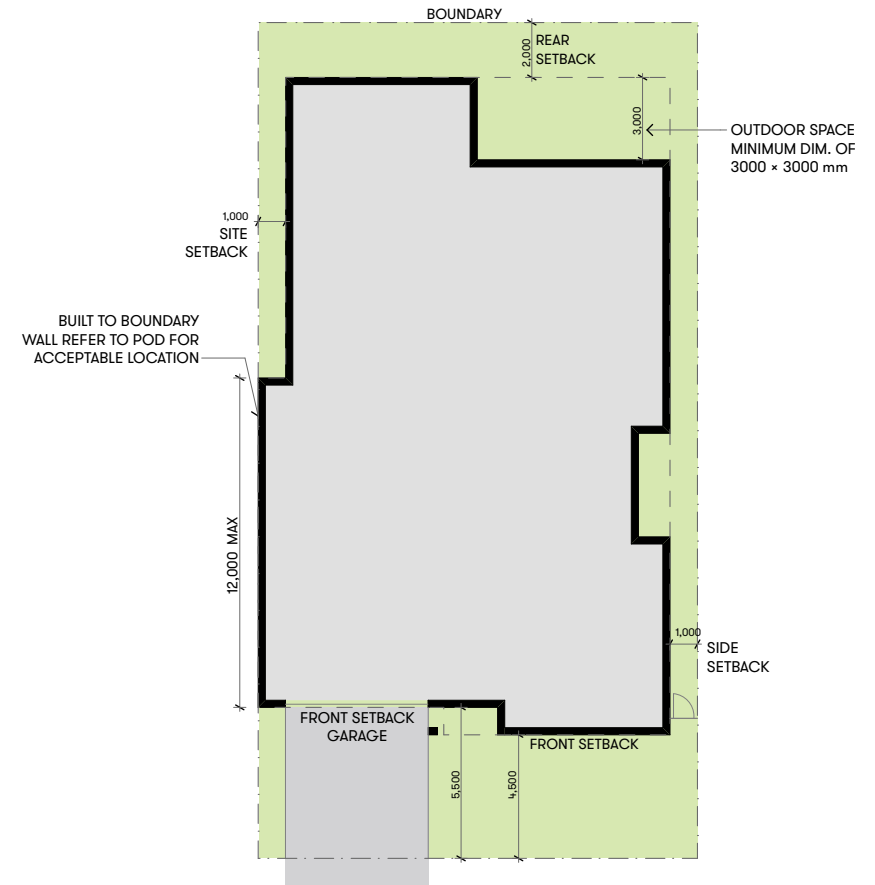

Figure 1 - Diagram of Lot with Setbacks

All dimensions in millimetres

3.2 Private Open Spaces

Private open space areas include patios and covered outdoor living areas as well as backyards.

Refer to the Plan of Development relevant to your lot for more detail regarding private open spaces for single and two storey dwellings.

3.3 Built to boundary walls

Built to boundary walls are optional. Check the POD applicable to your lot.

3.4 Building Heights

Homes at Riverton can be a maximum of two storeys. The maximum height of buildings can be 8.5m to the peak of the roof. Refer to the POD relevant to your lot.

3.5 Floor Levels

Floor levels are to be set to facilitate safe entry into the home and the garage.

3.6 Bushfire Management

Some lots within Riverton may be impacted by Bushfire controls due to the proximity of bushland environmental corridors. Where applicable, a plan and report will be provided to you as a part of the contract.



IMAGE COURTESY OF METRICON HOMES

4.0 Building Appearance

Homes at Riverton should reflect our Queensland climate and lifestyle. Classic Queenslander elements such as decks, weatherboard and Colorbond roofs are encouraged.

4.1 Pleasing Home Designs

Homes should have:

- 4.1.1 Have proportions that are aesthetically pleasing
- 4.1.2 Use of gabled roofs
- 4.1.3 Have a distinctive porch / front veranda entry
- 4.1.4 Use asymmetrical design
- 4.1.5 Have articulation (variation) in the front facade
- 4.1.6 Use prominent windows in the front facade
- 4.1.7 Have a selection of compatible facade materials, using a minimum of two material types
- 4.1.8 Have a living room or bedroom window fronting the street
- 4.1.9 Ornamentation such as glazing bars, mouldings, perforated metal panels, lace work and exterior glossy wall tiles and reflective glass finishes are not permitted.



Aesthetically pleasing proportions



Gable roofs



Distinctive porch / front entry



Asymmetrical design



Variation in front facade



Unacceptable facade treatment



Prominent windows in front facade



Unacceptable ornamentation

4.2 Building Materials and Colours

Warm, natural materials with colours that blend with the environment are encouraged for Riverton homes.

Using a variety of materials and colours excluding bold primary colours that work well together will assist in creating a well-designed home. It is suggested two or up to a maximum of three different materials be used on the exterior of your home along with three different colours. The colours and materials of your home should continue around the corner of the home at least to the point where the side return fence is attached to the house.

NOTE: Use of bold primary colours is not permitted.

4.2.1 Materials you might choose for your home include:

- Weatherboard eg: Traditional weatherboards,
- James Hardie ‘HardiePlank’, James Hardie ‘Linea Board’.
- Rendered or bagged and painted brick
- Face brick, face stone eg: Traditional brick finish, Boral ‘Cultured Stone’
- Rendered blueboard – preferably not on the front facade

The owner must not erect or place or permit to be erected or placed upon the lot any building previously erected on any other land nor will the owner (prior to the erection of a permanent dwelling on the lot) place any caravan, mobile home, tent or other similar living shelter on the lot. The owner must not use or permit to be used any caravan and/or mobile home parked on the lot, tent or any shelter on the lot other than the dwelling to be used as accommodation by any person.

The owner must not carry out any building works or landscaping on the lot which would impede access for building or normal maintenance purpose by or on behalf of the owner of any lot adjoining the lot who has built or may build a building along the boundary between the lot and that adjoining lot.

4.3 Corner allotments

Corner allotments require additional attention. It’s important that homes on corner allotments:

- 4.3.1 Address both street frontages
- 4.3.2 Include windows in the secondary street facade (or side of the home) and be of a similar size and style to windows in the front facade of your home
- 4.3.3 The side facade should be articulated with elements such as a return verandah / entry / portico / balcony or open gable feature for interest.
- 4.3.4 Large sections of non-articulated walls are not permitted.
- 4.3.5 For two storey corner lots ensure that the ground level facade material is different to the second storey facade material to provide articulation to the overall elevation.



5.0 Car Parking, Garages & Driveways

5.1 Car Parking

Homes must have parking for two cars per dwelling side by side in an enclosed lock up garage.

5.2 Vehicle Crossovers

Only one vehicle crossover is permitted per lot in accordance with Logan City Council (LCC) standard for driveways and crossovers.

5.3 Driveways

Only one driveway per lot is permitted. Driveways should comply with Logan City Council requirements. In addition:

- 5.3.1 Back of kerb to be saw cut / removed as per Logan City Council LCC standard
- 5.3.2 Driveways should extend from the edge of the kerb to the garage /carport.
- 5.3.3 To soften the surfaces of your home, provide at least 1m of screen planting between the driveway and side boundary (where possible). Please include this in your landscape plan for approval.
- 5.3.4 Driveways should be constructed from materials and colours that complement the home and the landscape. Materials may include coloured concrete or exposed aggregate. Plain grey broom finished concrete is not acceptable.
- 5.3.5 Driveways should not be built over or around infrastructure services in the verge such as pits / valves.

NOTE: Your driveway must be completed prior to the occupation of your home.



IMAGES COURTESY OF GJ GARDNER HOMES

6.0 Fencing and Gates

Fences make a big impact on the visual appeal of neighbourhoods. To create a friendly neighbourhood fence designs should follow the following design criteria:

6.0.1 Street Frontage Fence:

1. Maximum 1.2m high
2. Minimum 50% Transparency

6.0.2 Fences to public open spaces such as parks:

1. Maximum 1.8m height
2. Minimum 50% Transparency

6.0.3 Side and Rear Fences (see Section 6.1 for Secondary Street Fencing)

1. Maximum 1.8m height
2. Pleasing to look at on both side
3. Located at least 600mm behind the adjacent enclosed building line.

6.0.4 Gates and Side Return Fencing:

1. Must match fence construction and material
2. Painted to match the colour scheme of your house

6.0.5 Fence material permitted:

1. Treated timber
2. Composite timber material
3. Pre-painted steel type fence such as Colorbond and Stratco
4. Powdercoated finished aluminum batten fence

Where the Seller has constructed a fence wholly or partly on the lot, the owner must, at the owner's sole cost:

- (a) keep the fence at all times in good repair and condition; and
- (b) not remove, replace or alter the fence without the prior written consent of the Seller,

and the owner indemnifies the Seller and will keep the Seller indemnified against all loss and damage occurred by the Seller as a result or indirect result of the owner's failure to comply with the obligations contained in this clause and its sub-clauses.

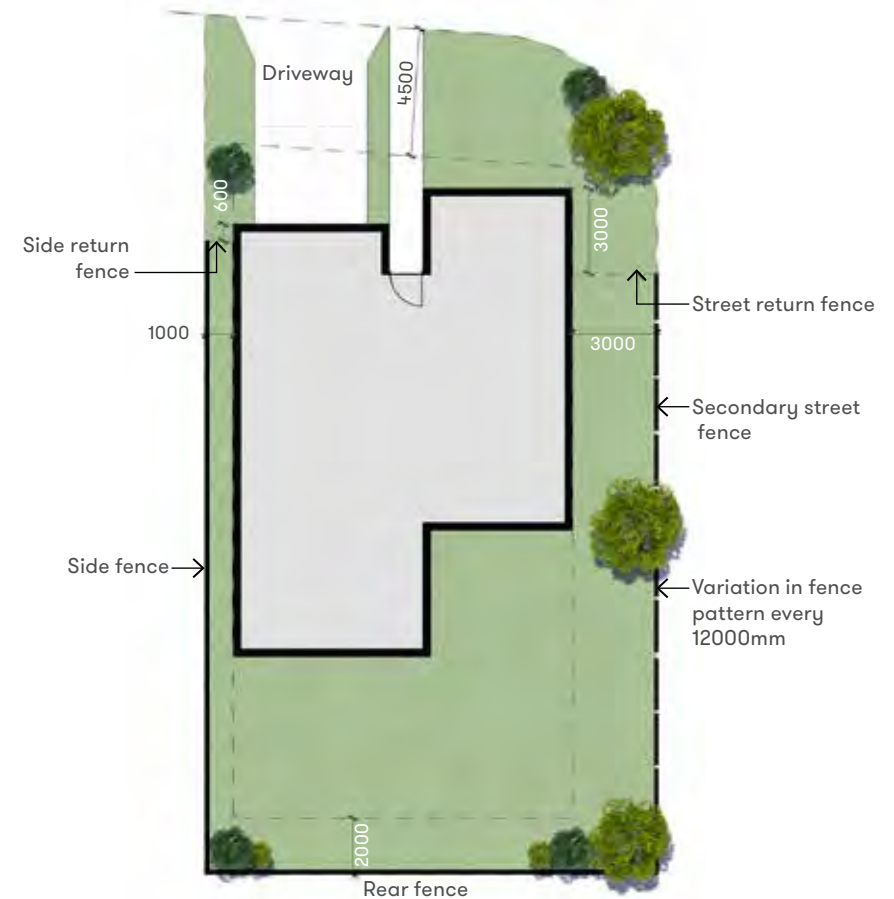

Figure 2 - Side Fencing on Corner Lots

All dimensions in millimetres

6.1 Secondary street fencing

Having a standard fence for corner lots will bring a high standard of visual appeal to Riverton and will last for many years. We have chosen a simple, easy to construct timber fence that will be unique to Riverton.

Side fences, or secondary fences, on corner lots should be:

- 6.1.1 25% transparent.
- 6.1.2 A maximum of 1.8m high.
- 6.1.3 Vary fence with change in fence pattern (Horizontal palings) at maximum every 12m length. The change in fence pattern to be a max of 2,100mm in length.
- 6.1.4 Constructed out of timber post and rail with treated pine paling
- 6.1.5 Painted to match the colour scheme of your home.
- 6.1.6 A side return fence facing the street should be located between 0.6m and 3.0m back from the front facade of your home and painted to match the colour scheme of your home.
- 6.1.7 The side gates in the side return fence facing the street should be of the same material as the side return fence and be 1.8m high maximum.

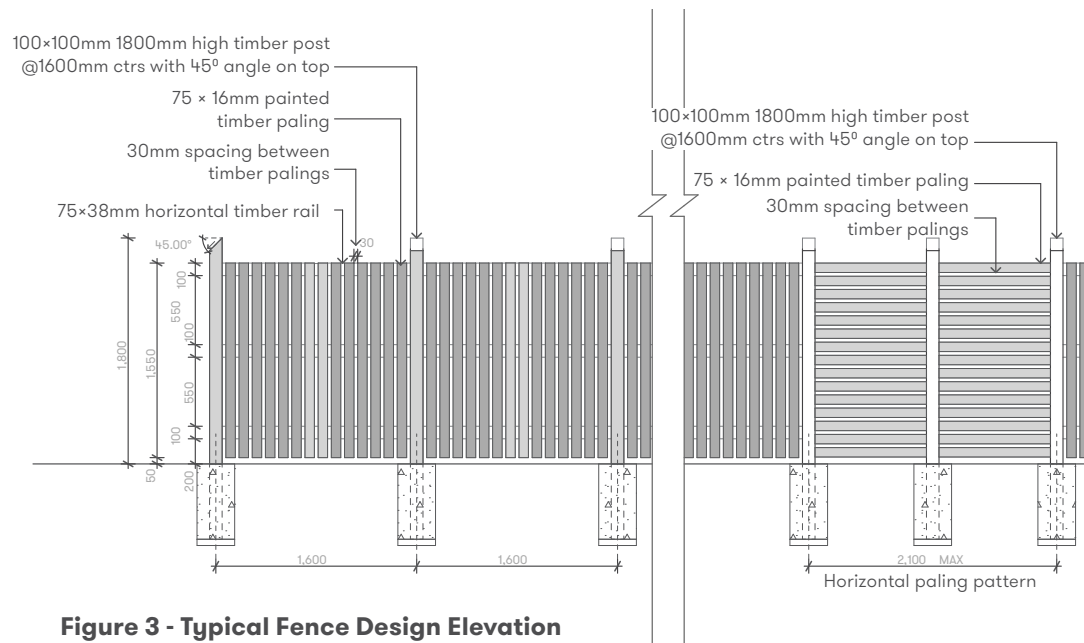

Figure 3 - Typical Fence Design Elevation
All dimensions in millimetres

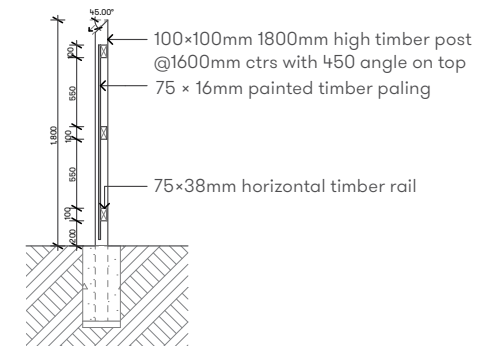

Figure 4 - Typical Fence Detail Section
All dimensions in millimetres

7.0 Other Elements of Your Home

7.1 Letterboxes

Letter boxes should be pillar style (not on a pole) and complement the materials and colours used in the façade of your home.

They should also be incorporated into the landscape and be clearly visible and identifiable from the street.

- 7.1.1 Where reinforced fibre concrete pillar letter boxes are installed, provide a landscaped garden edge to prevent damage from grass trimmers.

7.2 Garages

- 7.2.1 A minimum of a double garage is required to all homes. Homes to be designed to minimise the visual impact of the garage dominating the streetscape.
- 7.2.2 Garages are not to be the closest part of the home to the street and should be setback at least 1m behind another part of the home. Check the POD for the maximum size and width of garage permitted on your lot.
- 7.2.3 Garages are to be constructed adjoining the home and not separate to the home.
- 7.2.4 Garages should be compatible with the main building in terms of height, walls, windows, roof forms, colours and materials.
- 7.2.5 For larger lots with 3 garages, the 3rd garage is to be recessed by at least 500mm to the main garage wall.

7.3 Entry doors

The main entry door on the front façade is to be a minimum 920mm wide door. Side light must be provided if the door is less than 920mm wide.

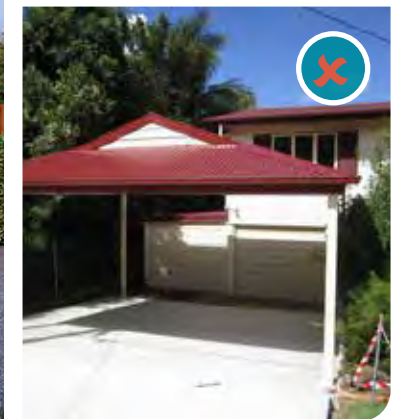

IMAGE COURTESY OF METRICON HOMES

7.4 Curtains, Blinds and security screens

- 7.4.1 For privacy and street appeal, curtains or blinds should be installed on all windows visible from the street prior to the occupation of your home. The colours should be complementary to the home's colour scheme when viewed from the outside.
- 7.4.2 Security / screen doors facing the street must be black mesh screen similar to the Crimsafe® range. Diamond grill screens are not permitted on the primary street facade of the home.

7.5 Overhangs, Decks, Awnings & Eaves

Decks, balconies, porches, awnings and eaves are an important element of your home's design and can improve your lifestyle and provide shading to keep your home cool. Refer to the Plan of Development (POD) relevant to your lot for the setbacks of these elements.

Decks, balconies and porches should be designed to emphasise the entrance to your home without dominating the front of the home and should complement the style, materials and colours of the home.

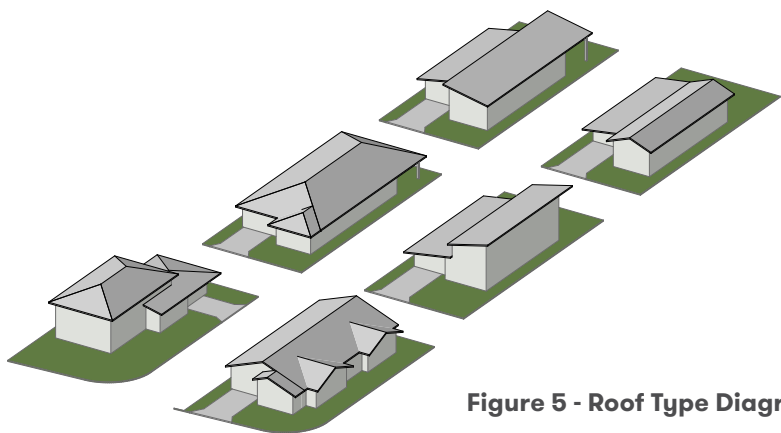

Figure 5 - Roof Type Diagrams

7.6 Roofs

Roof designs that are a simple composition of shapes will aid in reducing their visual prominence and improve the design and visual appeal of the home. Roof planes should be visually interesting and complement the dwelling design. The use of gables is encouraged. In addition:

- 7.6.1 A break in length to the roof should be provided for fascias longer than 15m, where it is fronting a street
- 7.6.2 Roof colours should be chosen to complement the home, keeping in mind that light coloured roofs keep the home cooler in summer. Natural, earthy colours are encouraged. Highly reflective and unfinished materials are not accepted.
- 7.6.3 Pitched roofs should be at a minimum of 22.5° (hip or gable)
- 7.6.4 Skillion roofs should be at a minimum of 5° and max of 12°.

7.7 Gutters and Downpipes

Gutters and downpipes should be painted to match or complement the dwelling. Having some variation in the roof and gutter line will improve the home's design.

7.8 Pools

All residential pools must meet local council requirements and all pool filters and associated equipment must be screened from view.

7.9 Display

- 7.9.1 The owner acknowledges that the Seller will be operating a display home near the lot and at the entrance to the estate in which the lot is located and additional car park, amenities, park and sales office from mid 2021 and the Buyer will not Object on the basis of this.
- 7.9.2 The owner must not, without the prior written consent of the Seller, use, promote, advertise or permit any structure erected on the Land to be used, promoted or advertised in any way as a display home.

8.0 Ancillary Fixtures

Ancillary fixtures refer to any additional item external to the home such as air conditioning units, hot water systems and rainwater tanks.

8.0.1 Air-conditioning units should:

- 8.0.1.1 Not be visible from the street or park areas
- 8.0.1.2 Be located below eave lines and screened from public view
- 8.0.1.3 Not be roof mounted
- 8.0.1.4 Be located to ensure that there is minimal noise impacts on neighbouring properties
- 8.0.1.5 Retro-fitted air-conditioners to windows which are visible from the street or public open space are not permitted.

8.0.2 Please ensure hot water services, clotheslines, satellite dishes, rainwater tanks, spa pumps and garbage bins are not visible from the street or public open space areas by considering these items when designing your home. Plan your home layout to ensure these items are hidden from view or include screens with fences or enclosures that complement the materials and colours of your home.

8.0.3 Where possible, solar hot water panels, solar panels and TV antennas should not be placed on the front facing roof of your home and have minimal visibility from the street or public open space.

8.0.4 TV antennas should have be a max height of 2m high at the rear of the dwelling and satellite dishes should be mounted below the roof line or where not visible from the street or public open space.

8.0.5 Ancillary and Outdoor Structures [eg. garden sheds]

- 8.0.5.1 Ancillary structures which impact the streetscape such as garden sheds, retaining walls, gazebos and swimming pools require approval by the 'Riverton' Design Review Committee.
- 8.0.5.2 Garden Ancillary structures should be constructed from materials and colours that complement the home.
- 8.0.5.3 Garden sheds should be of non-reflective material and should be a maximum of 2.5m high and screened from public view and are less than 10m².
- 8.0.5.4 Single storey sheds greater than 10m² may be considered by the RDRC provided that the external materials are consistent with those of the main dwelling.



9.0 Secondary Dwellings and Dual Occupancies

Secondary Dwellings and Dual Occupancies proposed to be constructed on a lot must be submitted to the RDRC for assessment and approval prior to any works commencing.

The Buyer must not, without the prior written approval of the Seller, erect or place upon the lot more than one dwelling nor use or permit to be used any dwelling for any purpose other than the accommodation of a single family. These dwellings must comply with the Logan Planning Scheme and may be subject to further development approvals and the payment of additional charges to Logan City Council. The design considerations that the RDRC will base their assessment on (external to any Logan City Council requirements) are as outlined below:

9.1 Secondary Dwelling

Any secondary dwelling must be designed so that:

- 9.1.1 The secondary dwelling is to have a minimum 1.5m wide setback to the side boundary.
- 9.1.2 There must be a fully formed concrete path a minimum of 1m wide with a landscape strip along the boundary fence from the street to each front door.
- 9.1.3 There should be no gate between the street frontage and the door to the secondary dwelling.
- 9.1.4 To maintain privacy for the primary / front dwelling, any side windows onto the entry path for the secondary dwelling should have sills of 1.7m.
- 9.1.5 There should be no obstruction such as hot water systems, airconditioning units or clothes lines between the street frontage and the door to the secondary dwelling.
- 9.0.6 There must be eaves or a covering over the path to the door of the secondary dwelling.

9.2 Dual Occupancy

- 9.2.1 Potential Dual Occupancy lots are generally located on corner lots and lots with a frontage greater than 15 meters.
- 9.2.2 Corner lot dual occupancies must address the both street frontages and has a clearly evident and well-lit access to the front door of each dwelling.

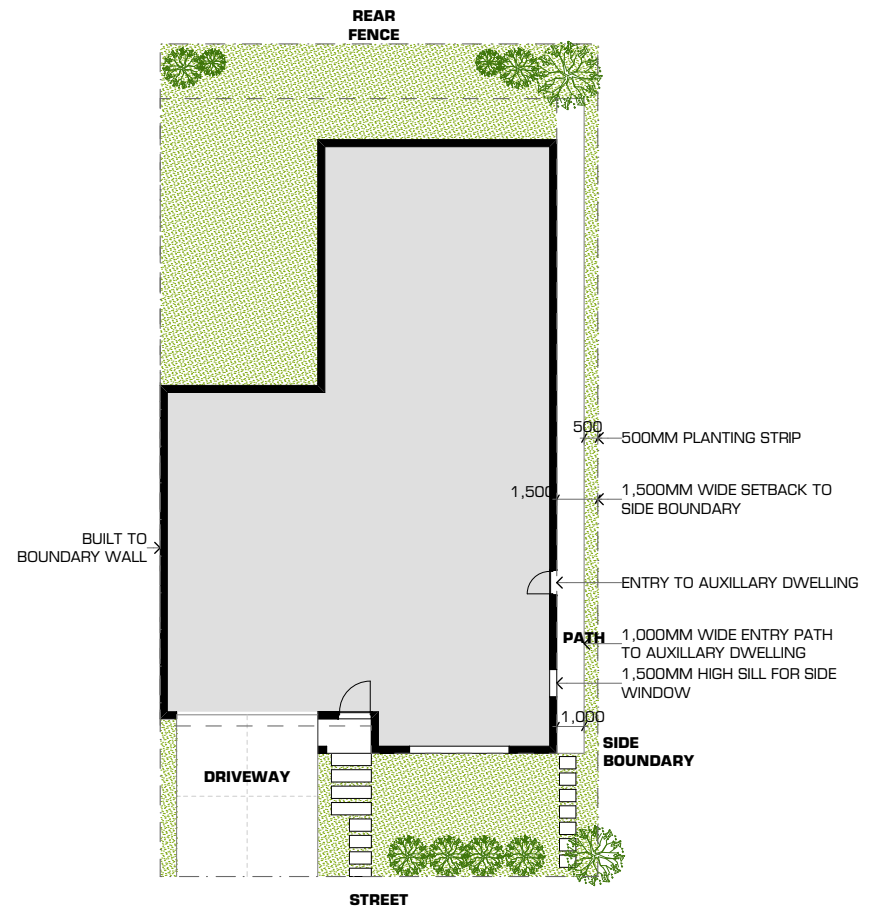

Figure 6 - Secondary Dwelling

All dimensions in millimetres

10.0 Sustainable Design

Including sustainable design features in your home helps the environment and can also help you. Considering things like the orientation of your home can improve your comfort by making sure it's warm in winter and cool in summer. It can also save you in energy costs by reducing the need to heat or cool your home. Some sustainable design features you might like to consider include:

10.1 Energy Efficiency

In addition to orienting your home for passive heating and cooling, other things to consider to reduce energy bills include:

- 10.1.1 Choosing a good orientation for your home to reduce the need for fans, air conditioning and heaters (see diagram right)
- 10.1.2 Ensuring windows are placed to encourage cross-ventilation
- 10.1.3 Window glazing and glass treatments
- 10.1.4 Using louvers
- 10.1.5 Use wide eaves, awnings and screening on windows for shade particularly on western windows
- 10.1.6 Choosing a light colour for your roof and external walls
- 10.1.7 Using insulation in external walls and ceilings, particularly non-masonry walls
- 10.1.8 Install efficient hot water systems or consider the use of solar hot water systems
- 10.1.9 Install energy efficient appliances
- 10.1.10 Install outdoor clothes lines
- 10.1.11 Use energy efficient lighting such as low energy LED and fluorescent lighting and sensors
- 10.1.12 Construction materials

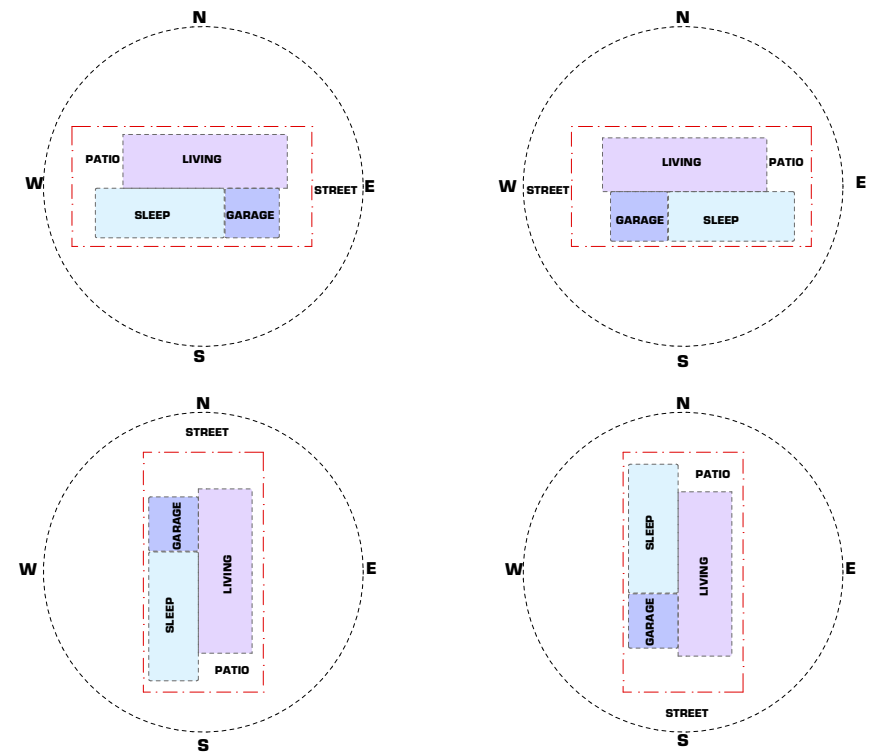

Figure 7 - Orientation Diagrams

10.2 Orientating your home

Choosing the right orientation for your home is important. It will help ensure your home is cool in summer and warm in winter. Living areas should be located in the north and eastern areas of your home to capture breezes and to avoid the heat of the western sun. The diagrams provide some ideas on how best to orientate your home.

10.3 Water Efficiency

Some things you can do to save water and reduce your water bill include:

1. Install a rainwater tank and connect it to toilet cisterns, the laundry and external taps to use to water your garden
2. Install 4 star WELS rated fittings such as taps, shower heads and toilets as well as appliances such as dishwashers and washing machines to reduce water usage
3. Consider the location of your hot water system to be close to most used areas such as bathrooms to reduce wasting water while it's heating and consider installing hot water recirculation systems
4. Use drought resistant plants and ground covers where grass is not needed eg: mulch
5. Wash cars, caravan and boats on the grass where possible



10.4 Recycling and Waste Management

Along with ensuring you recycle the waste in your home and use composting when you've moved into Riverton, maximising the use of pre-fabricated building components is also a sustainable choice when building.

10.5 Creating Healthy Homes

Create a healthy home by:

1. Considering the types of paints, glues, plastics, and some manufactured wood products you choose when building your home. Some can release chemical substances at room temperature, called VOC's (Volatile Organic Compounds). Consider the toxicity, quantity and proximity of materials you are using.
2. Ensure cross-ventilation through good design, ceiling fans and mechanical ventilation in bathrooms.
3. Consider the use of natural materials for bench tops, splashbacks, doors, shelves and cabinetry, and floors. Products such as natural stone, reconstituted stone, natural timber and recycled wood products are good choices.
4. Improving Site Management

Consider the following when building:

5. Minimise site cutting and exposure to weather
6. Reduce soil erosion
7. Maintain waste in a closed receptacle

11.0 Landscaping, Gardens and Yards

The use of landscaping will vastly improve the way your home and your street looks and feels. Well designed outdoor spaces, gardens and yards for play and relaxation can improve your lifestyle.

Planting trees is encouraged for privacy, shade, texture and colour. We encourage you to plant trees that attract native birds and wildlife and for the enjoyment of future generations at Riverton. Investing in mature native trees and plants that are hardy and drought tolerant will help your landscape establish quickly.

Examples of good garden design options are provided below. They include practical and environmentally sustainable outcomes. A schedule of plant species is provided for assistance in selecting recommended plants suitable for the area.

Landscape to be complete within 3 months of completion of your home.

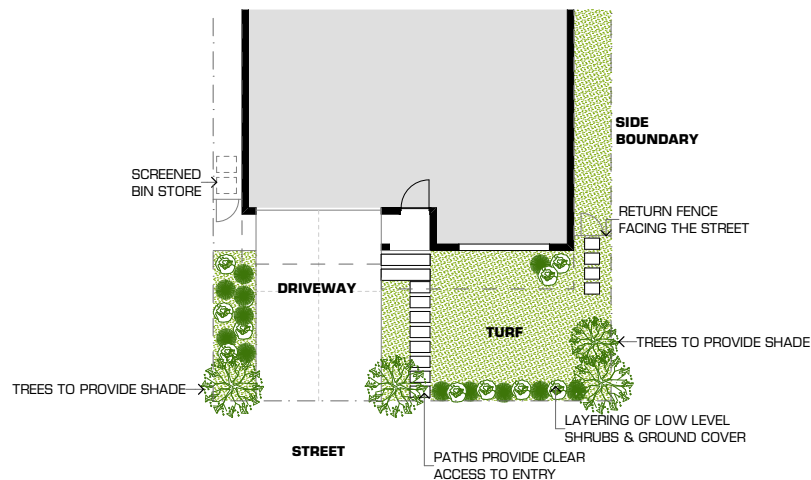

Figure 8 - Typical Front Yard Landscape

11.1 Design and Planning Considerations

Things to consider when designing your landscaping:

1. Orientation of the gardens to consider the degree of exposure to prevailing winds and sun
2. Soil type and depth of top soil.
3. Minimisation of water requirements – plant selections and mulching.
4. Mulching with organic materials such as pine bark or forest mulch etc will assist in maintaining ground moisture by reducing evaporation and adding nutrients to the soil.
5. Low level shrub planting between the houses and street to promote privacy
6. Potential shading and screening benefits of trees and plants
7. The location of your home within Riverton, the adjacent river and natural surroundings
8. Ultimate size of trees and plants when fully grown
9. Habitat values
10. Ensure trees are given good clearance from in-ground services and the footings of your house.

11.2 Retaining walls

Some lots within Riverton have retaining walls built by the Seller close to the boundaries to create a building pad. Where your house is on the lower side of a retaining wall you must maintain any subsoil drain from that wall and connect it into the yard drainage system for your house.

Where there is an overland flow path or roof water system at the rear of a lot, that system must be protected and the function of any continuous overland flow path must be maintained so that water is transported from upstream properties with no damage to surrounding property. No fill is to be placed over the easement or swale drain.

- 11.2.1 Any retaining wall built on your lot must be constructed in accordance with Council regulations.
- 11.2.2 Retaining walls and site preparation to be completed by the builder
- 11.2.3 Retaining walls in the front yards are permitted if they are split faced Masonary or A grade sandstone blocks.
- 11.2.4 Timber sleeper walls and plain grey concrete sleeper walls are not permitted forward of the building line.

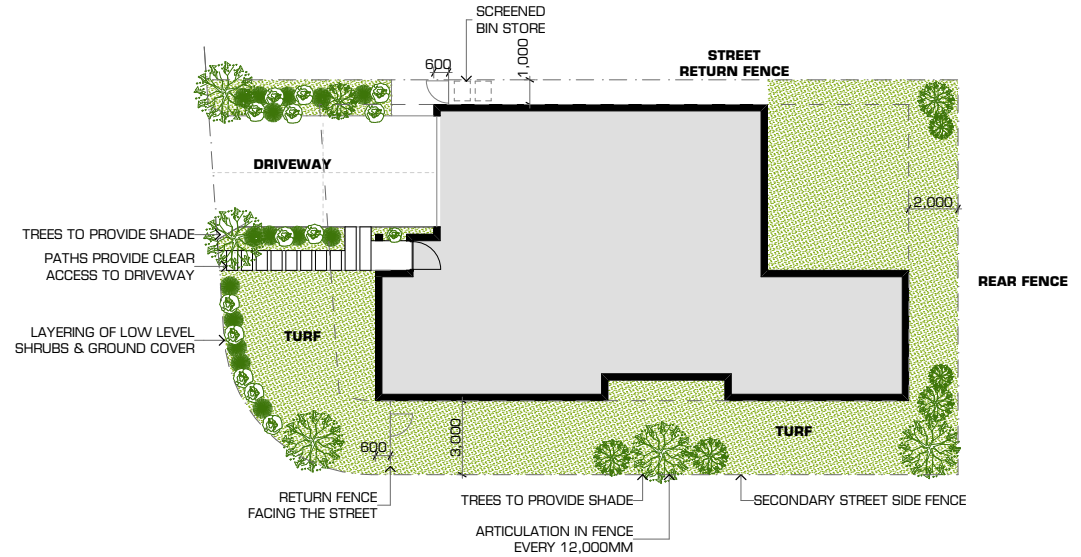

Figure 9 - Typical Frontage Landscape for Corner Lots - Option 1

All dimensions in millimetres

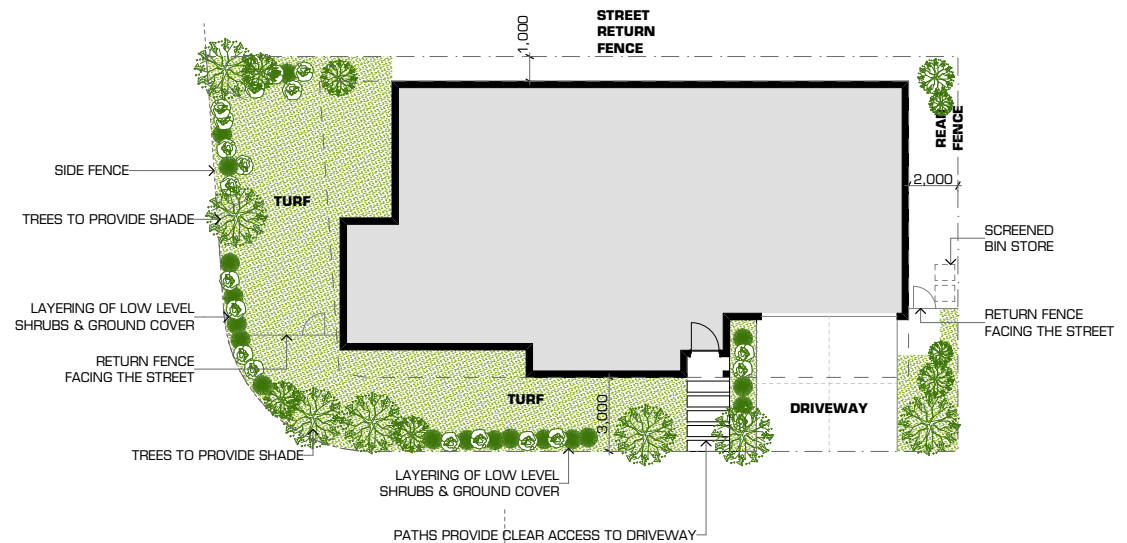

Figure 9 - Typical Frontage Landscape for Corner Lots - Option 2

All dimensions in millimetres

11.3 Native Planting

A mix of exotic and native species in your selection creates water efficient, low nutrient gardens that also supplement surrounding habitat for local wildlife and birdlife.

A landscape of shrubs and trees provides screening for privacy, shade from the extremes of the summer sun, directs movement towards entrances and can soften the appearance of building forms from the street.



IMAGE COURTESY OF METRICON HOMES



IMAGE COURTESY OF METRICON HOMES



IMAGE COURTESY OF METRICON HOMES



IMAGE COURTESY OF METRICON HOMES

12.0 Services at Riverton

Riverton is a National Broadband Network (NBN) enabled community.

Phone and internet services will be provided by retailers over the National Broadband Network. Connection details are available at www.nbnco.com.au.

1. Natural gas is not available at Riverton
2. Free to air TV will require an antenna



13.0 Construction Guidelines

NOTE: Please make sure you and your builder are aware of the construction guidelines to ensure the safe and considerate construction of your home.

13.1 Site Access

- 13.1.1** Building access to each lot during construction is to be limited to a single entry /exit point that is stabilised with gravel or similar material to protect the kerb.
- 13.1.2** The remaining street frontage is to be barricaded with tape of similar to prevent access. This will assist in controlling the tracking of sediment throughout the site.
- 13.1.3** Any material or mud deposited on roadways must be removed daily.
- 13.1.4** Adjoining lots or park areas may not be used for construction access at any time.
- 13.1.5** Any damage to the footpaths, kerbs, roads or street landscaping must be repaired by the owner of the lot.

13.2 Hours of Construction

- 13.2.1** Hours of construction shall be in accordance with the (Logan City Council Planning Scheme Policy 5)
- 13.2.2** No building work is allowed on Sundays or public holidays

13.3 Storage of Materials

- 13.3.1 All building materials must be contained within the lot.
- 13.3.2 Materials are not to be stored on park areas, streetscapes or adjoining lots.

13.4 Rubbish

- 13.4.1 You must not allow rubbish to accumulate or allow excessive growth of grass or weeds upon your allotment, both before and after construction of the dwelling.
- 13.4.2 All rubbish during construction is to be enclosed within a skip. The skip is to be contained within the lot.
- 13.4.3 No builder's rubbish is to be deposited on adjoining lots or on to the streetscape.

13.5 Site Clean Up

- 13.5.1 You must comply with any request by the Seller or Council to clean up an overgrown site or builder's materials.
- 13.5.2 If you fail to comply within 14 days of receiving a written notice from the Seller then you will be liable to reimburse the Seller all costs, including administration costs, incurred in the removal of such materials and repairs.

13.6 Noise

- 13.6.1 Builder's noise must be kept to a minimum. Loud music is not permitted.

13.7 Temporary Amenities

- 13.7.1 Temporary toilet facilities are to be provided at each construction site.
- 13.7.2 Toilets are to be located within the boundaries of the lot.

13.8 Workplace Health & Safety

- 13.8.1 Builders must comply with all relevant Workplace Health and Safety requirements relating to residential building construction.



13.9 Maintenance of Allotments and Verge

- 13.9.1** All infrastructure and landscape within the verge is to be protected during construction.
- Any damage to trees, concrete paths, road pavements, kerbs and turf or services located in the verge is the responsibility of the owner to reinstate at their sole cost.
- 13.9.2** The owner and their builders must meet all environmental and WHS requirements of all authorities and must keep the site in a neat and tidy condition throughout the construction period including the control of sediment erosion.
- 13.9.3** No building materials or rubbish are to be left on the verge at any time during construction. No building materials or spoil are to be placed on any adjoining lot during construction.
- 13.9.4** The owner must keep and maintain all improvements constructed on the lot, all entry statements, landscaping and all lawns, trees, shrubs and gardens (whether on the lot or on any footpath adjoining the lot) in good order and condition.
- 13.9.5** The owner will not bring on to, nor allow to accumulate on the lot any weeds, rubbish, garbage, spoil or other material of an unsightly nature and must not install an incinerator or other article for the disposal of or storage of garbage except for a domestic rubbish bin.
- 13.9.6** If the Seller is required to expend any money in enforcing the covenants under these guidelines, then the owner acknowledges and agrees that the Seller may require the owner to reimburse the Seller for these costs (being a liquidated debt payable immediately to the Seller on demand).

13.10 Tenants

If dwellings are tenanted, it is the lot owner's responsibility to ensure that the lot is maintained to the required standard.

13.11 Vehicles

- 13.11.1** You are not permitted to park unregistered vehicles in your driveway or front yard.
- 13.11.2** Commercial vehicles, boats and caravans may be parked on a lot but must be screened from public view.





14.0 Disclaimer

The Seller reserves the right to not approve any house design and the right to approve non-conforming designs that would not otherwise require statutory approval.

The Seller also reserves the right to vary the requirements of the Home Design Guidelines subject to Council Approval.

Unless otherwise indicated, where a relaxation or variation is granted, it is for a specific lot and is not to be taken as a variation to the Home Design Guidelines as a whole.

Any approval granted by the Seller/Developer under these Home Design Guidelines is concerned only with the style, appearance and suitability to the Development of the proposed improvements and is not intended to warrant or guarantee the soundness, structural or otherwise, of any proposal to construct improvements on the Land, submitted to the Seller/Developer by the Buyer.

The Buyer should seek expert advice with respect to the soundness, structural or otherwise, of any proposal for the construction of improvements on the Land.

The Seller/Developer shall not, in any circumstances, be liable for any damage or loss (including direct, indirect and consequential damage or loss), caused to the Buyer through the negligent construction of improvements on the Land.

The Seller/Developer's Home Design Guidelines enforcement responsibility will terminate 3 months following the sale of the final allotment within Seller / Developer's Estate.

The Home Design Guidelines as prepared by the Seller ceases to apply at the time that the Seller/Developer's Home Design Guidelines enforcement responsibilities are terminated.

15.0 Application Checklist

Complete the application form attached to this document and send it along with drawings to the Riverton Design Review Committee.

Email: rivertondesign@avjennings.com.au

Drawings Checklist

The below drawings need to be submitted with your application form.

1.0 Site plan with the following illustrated

- Contours at 500mm intervals and building footprint[s] positioned on lot [1:100 / 1:200 scale] including:
 - North point
 - Lot size sqm
 - Lot dimensions [width and depth]
 - Setbacks and location of all buildings and structures **(Refer to Clause 3.1)**
 - Finished ground levels **(Refer to Clause 3.5)**
 - Easements
 - Services [electricity pillar, street trees, communication pits etc] **(Refer to Clause 3.0.2)**
- Site cross section indicating natural ground level from boundary to boundary showing integration of built form and retaining walls. **(Refer to Clause 11.2)**

2.0 Floor plans [1:100 scale] illustrating

- Internal layouts indicating location of windows, doors, stairs, built-ins, changes in level etc.
- Site cover is consistent with POD % **(Refer to Clause 3.1)**
- Private open space to have a minimum dimension of 3m in one direction. Area – to be incorporated into the building fabric. **(Refer to Clause 3.2)**
- All walls, openings etc to be dimensioned.
- Roof overhangs to be shown and dimensioned. **(Refer to Clause 7.5 & 3.0.4)**

3.0 Earthworks plan –

- Indicating extent of cut & fill

4.0 Roof plan [1:100 scale]

(Refer to Clause 7.5 - 7.8 & 8.0)

- Illustrating overhangs & setbacks

5.0 Retaining wall details

(Refer to Clause 11.2)

- Location
- Construction and height [if applicable]

6.0 Electrical Plan

(Refer to Clause 8.0)

7.0 Landscape plan

(Refer to Clause 7.8 & All of 11.0)

- Including pool location (if applicable). Other pool details to include setbacks from boundary, pool pump location.

8.0 Fencing plan, sections and materials

(Refer to Clause 6.0.1 & 6.1.1 - 6.1.7)

9.0 Elevations & sections of dwelling (1:100 scale)

- Elevations to be designated by aspect ie. N/S/E/W
- Existing natural ground level indicated.
- Finished ground level indicated.
- Show elevations with true relation to actual site levels.
- Building height (RL & dimension) 8.5m above natural ground level, max. 2 storeys. **(Refer to Clause 3.4)**

- Roof form & pitch. **(Refer to Clause 7.6.3 & 7.6.4)**
- Materials - type & colour scheme for external walls, roofing, downpipes, driveways, pathways & fencing **(Refer to Clause 4.2 & 4.2.1 & 4.1.1 - 4.1.9 & 7.7)**

10.0 Ancillary fixtures and materials

Please submit documents to demonstrate compliance with the following:

- Above drawings to incorporate the location of all ancillary structures and the following:
- Solar panels. **(Refer to Clause 8.0.7)**
- Air conditioner. **(Refer to Clause 8.0.1 - 8.0.5)**
- TV Aerial or satellite dish location (below the roof line). **(Refer to Clause 8.0.8)**
- Letterbox detail and location. **(Refer to Clause 7.1)**
- Shed and outdoor structure location and details. **(Refer to Clause 8.1.1)**
- Hot water type and location. **(Refer to Clause 10.3.3.)**
- Water tank location [if applicable]. **(Refer to Clause 10.3.1)**
- Outdoor clothes drying area.
- Curtains and Blinds **(Refer to Clause 7.4.1)**
- Security screens **(Refer to Clause 7.4.2)**

16.0 Building Covenant Application Form

Important Information

Approval must be received from the Riverton Design Review Committee for the construction of new homes, garages, fences, landscaping and any other structures on any allotments within the Riverton community.

1.0 Description of Development

Contact Details

Property Owner:		
Address:		
		Postcode:
Home:	Work:	Mobile:
Email:		
Builder /Designer:		
		Postcode
Home:	Work:	Mobile:
Email:		

Site Details

Lot No:
Survey Plan:
Street Adress:

Please complete this form and return to: rivertondesign@avjennings.com.au

2.0 Drawing Checklist

<input type="checkbox"/> Completed design checklist (this document)	
<input type="checkbox"/> Site plan including building footprint(s) positioned on lot	1:200 scale
<input type="checkbox"/> Lot size m ² <input type="checkbox"/> Lot Dimensions (width and depth) <input type="checkbox"/> Setbacks (front, side and rear setbacks)	
<input type="checkbox"/> Easements <input type="checkbox"/> Services (electricity pillar, street trees, communications pits etc)	
<input type="checkbox"/> Architectural drawings - plans and elevations of buildings	1:100 scale
<input type="checkbox"/> Floor area m ² <input type="checkbox"/> Slab RL	
<input type="checkbox"/> Electrical Plan	1:100 scale
<input type="checkbox"/> Site cover (%)	
<input type="checkbox"/> External materials and colour selections (brick, colour render etc)	

3.0 Compliance with Relevant Documents

<input type="checkbox"/> Riverton Approved Plan of Development
<input type="checkbox"/> Riverton Home Design Guidelines
<input type="checkbox"/> National Construction Code (Building Code of Australia)

17.0 Landscape Planting Palette

Suitable Plant Species	
Trees and Palms	
<i>Acmena hemilampra</i>	Bush Satinash
<i>Callistemon viminalis</i>	Weeping Bottlebrush
<i>Elaeocarpus eumundii</i>	Eumundi Ash
<i>Elaeocarpus reticulatis</i>	Blueberry Ash
<i>Livistona australis</i>	Cabbage Palm
<i>Melaleuca linariifolia</i>	Snow in Summer
<i>Magnolia 'Little Gem'</i>	Dwarf Magnolia
<i>Pandanus pedunculatus</i>	Pandanus
<i>Ptychosperma elegans</i>	Solitaire Palm
<i>Tibouchina 'Alstonville'</i>	Lasiandra
<i>Xanthostemon chrysanthus</i>	Golden Penda
Shrubs	
<i>Acalypha 'Inferno'</i>	Red Acalypha
<i>Acmena smithii 'Allyn Magic'</i>	Dwarf Lilly Pilly
<i>Alpinia caerulea</i>	Native Ginger
<i>Bambusa species</i>	Bamboo (Clumping Types)
<i>Banksia robur</i>	Swamp Banksia
<i>Brunfelsia latifolia</i>	Yesterday Today Tomorrow
<i>Callistemon 'Captain Cook'</i>	Captain Cook Bottlebrush
<i>Clerodendrum nutans</i>	Bridal Veil
<i>Cordyline species</i>	Palm Lily
<i>Croton hybrids</i>	Crotons
<i>Dichorisandra thrysiflora</i>	Blue Ginger
<i>Gardenia florida</i>	Gardenia
<i>Grevillea 'Honey Gem'</i>	Honey Gem
<i>Heliconia 'Red Xmas'</i>	Red Christmas
<i>Hibiscus rosa-sinensis</i>	Rose of China
<i>Ixora hybrids</i>	Yellow Ixora
<i>Jasminium sambac</i>	Arabian Jasmine
<i>Melaleuca 'Claret Tops'</i>	Dwarf Paperbark



Acmena hemilampra
Bush Satinash



Callistemon viminalis
Weeping Bottlebrush



Elaeocarpus eumundii
Eumundi Ash



Elaeocarpus reticulatis
Blueberry Ash



Livistona australis
Cabbage Palm



Melaleuca linariifolia
Snow in Summer



Xanthostemon chrysanthus
Golden Panda



Acmena smithii 'Allyn Magic'
Dwarf Lillypilly



Banksia robur
Swamp Banksia



Dichorisandra thrysiflora
Blue Ginger



Cordyline species
Palm Lily



Grevillea 'Honey Gem'
Honey Gem

Suitable Plant Species	
<i>Melastoma affine</i>	Native Lasiandra
<i>Metrosideros 'Fiji Fire'</i>	Fiji Christmas Bush
<i>Mussaenda 'Aureora'</i>	White Mussaenda
<i>Orthosiphon aristatus</i>	Cats Whiskers
<i>Pittosporum revolutum</i>	Brisbane Laurel
<i>Plumbago auriculata</i>	Blue Blue Jasmine
<i>Raphis excelsa</i>	Raphis Palm
<i>Strelitzia reginae</i>	Bird of Paradise
<i>Syzygium hybrids</i>	Lillypillies
<i>Tibouchina Jules</i>	Dwarf Lasiandra
<i>Westringia fruticosa</i>	Coastal Rosemary
<i>Asplenium australasicum</i>	Crows Nest Fern
Grasses and Groundcovers	
<i>Cissus 'Ellen Danica'</i>	Water Vine
<i>Curculigo capitulata</i>	Palm Grass
<i>Gardenia radicans</i>	Prostrate Gardenia
<i>Goodenia ovata</i>	Prostrate Hop Goodenia
<i>Grevillea 'Royal Mantle'</i>	Royal Mantle
<i>Hemerocallis hybrids</i>	Day Lillies
<i>Hymenocallis littoralis</i>	Spider Lily
<i>Liriope species</i>	Strippy White, Evergreen Giant
<i>Lomandra hystrix</i>	Slender Mat Rush
<i>Myoporum ellipticum</i>	Coastal Myoporum
<i>Neoregellia compacta</i>	Compact Bromeliade
<i>Pratia pedunculata blue</i>	Blue Matted Pratia
<i>Scaevola "Purple Fanfare"</i>	Fan Flower
<i>Viola hederacea</i>	Native Violet
Suitable Varieties of Turf	
For Sunny Areas -	Green Couch - eg. 'Wintergreen', Greenlees Park' or 'Legend'
For shaded Areas	Zoyzia - eg. 'Empire' low mow variety For Shaded Areas - Buffalo - 'Sir Walter', 'Sapphire'



Viola hederacea
Native Violet



Strelitzia reginae
Bird of Paradise



Westringia fruticosa
Coastal Rosemary



Asplenium australasicum
Crows Nest Fern



Hymenocallis littoralis
Spider Lilly



Lomandra hystrix
Slender Mat Rush



Myoporum ellipticum
Coastal Myoporum



Metrosideros 'Fiji Fire'
Fiji Christmas Bush



Pratia pedunculata Blue
Blue Matted Pratia

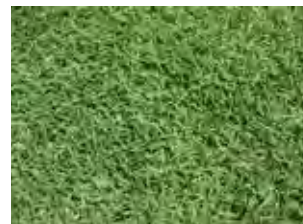

Green Couch - 'Wintergreen'



Zoyzia - low mow variety



Buffalo - 'Sir Walter'

RIVER[≡]TON

JIMBOOMBA

Disclaimer:

This document and all the content within informs part of the contract for properties in Riverton at Jimboomba. Illustrations, photos, maps and plans are indicative only and may not be to scale. It is recommended that prospective purchasers undertake their own enquiries for their own benefit and seek independent advice before entering into any agreement of any nature with any party.

AVJennings®