

# ┌ Cadence Home Design Guidelines.

Cadence  
RIPLEY



# Contents.

<b>1.0 Welcome</b>	<b>2</b>	6.1 Secondary street frontage fencing	14	13.3 Construction Rules	26
<b>2.0 Why have Design Guidelines?</b>	<b>3</b>	<b>7.0 Other Elements of Your Home</b>	<b>15</b>	13.4 Tenants	27
2.1 Design Approval Process	4	7.1 Letterboxes	15	13.5 Vehicles	27
2.2 Non-Conforming Designs	4	7.2 Entry doors	15	13.6 Site Clean Up	27
2.3 Construction Timelines	5	7.3 Curtains, Blinds and security screens	15		
2.4 The 'Design Approval' Process	6	7.4 Overhangs, Decks, Awnings & Eaves	17		
2.5 Design Guidelines Compliance	7	7.5 Roofs	17		
<b>3.0 Locating your home on your lot</b>	<b>8</b>	7.6 Gutters and Downpipes	17		
3.1 Private Open Spaces	9	7.7 Pools	17		
3.2 Built to boundary walls	9	<b>8.0 Ancillary Fixtures</b>	<b>18</b>		
3.3 Building Heights	9	<b>9.0 Duplex Lots and Secondary Dwellings</b>	<b>19</b>		
3.4 Floor Levels	9	<b>10.0 Sustainable Design</b>	<b>20</b>		
3.5 Bushfire Management	9	10.1 Energy Efficiency	20		
<b>4.0 Building Appearance</b>	<b>10</b>	10.2 Water Efficiency	21		
4.1 Design Elements	10	10.3 Creating Healthy Homes	21		
4.2 Building Materials and Colours	11	<b>11.0 Landscaping, Gardens and Yards</b>	<b>22</b>		
4.3 Corner allotments	11	11.1 Design and Planning Considerations	22		
<b>5.0 Car Parking, Garages &amp; Driveways</b>	<b>13</b>	11.2 Retaining walls	23		
5.1 Car Parking	12	11.3 Native Planting	24		
5.2 Vehicle Crossovers	12	<b>12.0 Services at Cadence</b>	<b>25</b>		
5.3 Driveways	12	<b>13.0 Construction Guidelines</b>	<b>25</b>		
5.4 Garages	12	13.1 Site Access	25		
<b>6.0 Fencing and Gates</b>	<b>13</b>	13.2 Hours of Construction	25		

# Cadence, Ripley Home Design Guidelines.

We want Cadence, Ripley to be a community you'll love being part of. A community with homes that complement each other and their surrounding environment.

Our vision is to create a community with homes that are modern yet reference the Queensland climate by incorporating design elements, materials, colours and landscaping that are typically associated with Queensland homes. These design guidelines will assist you in creating your home at Cadence to meet this vision and will help ensure that your home and your neighbours' homes all complement one another. The Guidelines set a standard for home and garden design and encourage the use of sustainable design features and materials.

We've worked with architects, designers and builders to put together guidelines for homes that reflect current home design and building trends.

The guidelines will help you design a home that:

- Feels spacious and comfortable inside and out.
- Looks its best from the outside and maintains its appearance for many years.
- Adds value to your property by incorporating design principles that support sustainability.
- Is cool in summer and warm in winter.
- Makes the most of its location at Ripley.
- Suits the Queensland climate and lifestyle.
- Considers the Ripley Valley Priority Development Area (PDA) as a benefit toward design principles.



# Why have Design Guidelines?

Design Guidelines aim to set a standard for homes at Cadence, Ripley to provide residents with an aesthetically pleasing environment that will enhance your lifestyle now and into the future.

**Note: These Guidelines form part of your Land Sales Contract.**

## The Design Guidelines aim to:

- Work in harmony with the Ripley Valley Priority Development Area (PDA) stipulated by Economic Development Queensland (EDQ)
- Ensure that the character of Cadence, Ripley is protected and enhanced.
- Encourage a diverse, contemporary and harmonious range of homes and landscapes.
- Promote the use of sustainable building features.
- The Design Guidelines prescribe specific requirements for housing design, materials and finishes.
- Encourage the creation of homes that are in harmony with each other but not identical to each other.
- Provide a high level of presentation to the neighbourhood.
- Guidelines for external materials and colours.
- Standards for fencing, driveways and landscapes.
- A guide to understanding the covenant approval process.
- Timeframes in which you need to complete building your home.
- Timeframe in which you need to complete the front landscaping to your home.

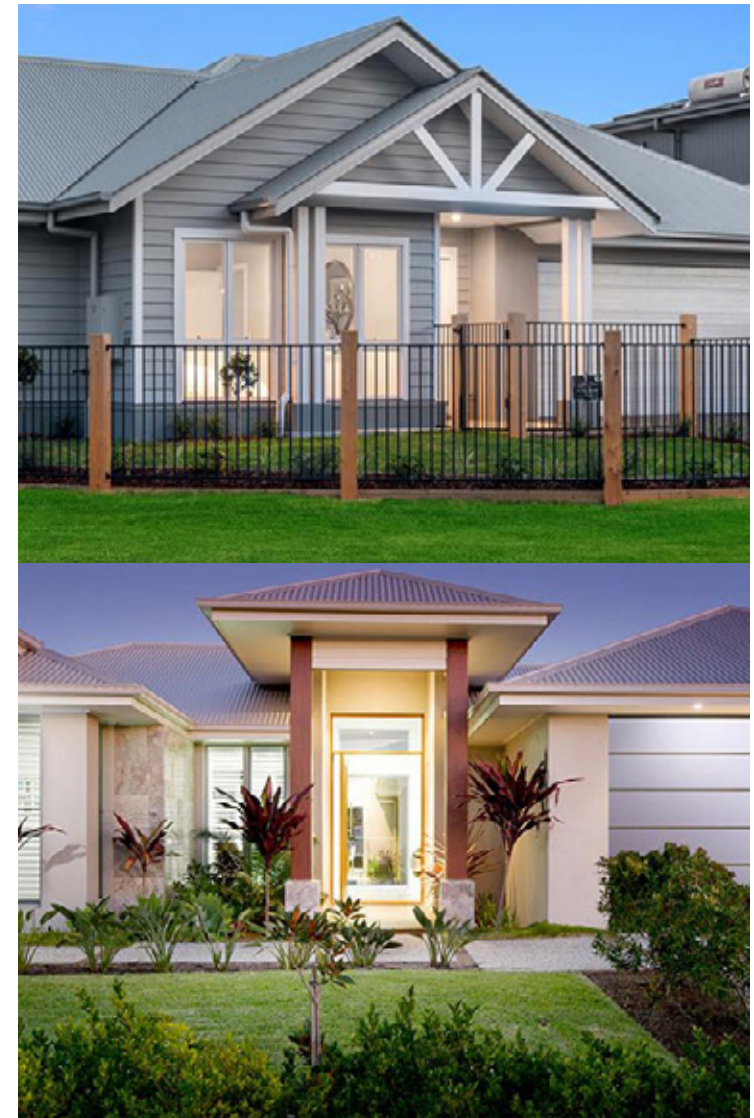



## 2.1 Design Approval Process

The **Cadence, Ripley** Design Review Committee' (DRC) is responsible for ensuring the homes built at Cadence meet these Guidelines. You will need to submit your plans to the DRC and seek approval for them prior to building your home.

This includes seeking approval for all associated element of your home such as the garage, fencing and any other structures. It is also mandatory that you seek approval from the DRC before you seek Building Approval from EDQ / Ipswich City Council or a Private Certifier.

When choosing a home design, you might choose to select one of the approved designs from one of our partner builders. Cadence, Ripley has a number of builders who have already sought design approval for the home designs they can create for you at Cadence, Ripley.

Alternatively, you may submit your own design or that of your builder / architect to the DRC for review and approval. See sections 14 and 15 for information on submitting your design.

Email:  
[Cadencedesign@avjennings.com.au](mailto:Cadencedesign@avjennings.com.au)

The DRC will provide approval or otherwise of the working drawings within 15 days of their receipt. If amendments are required to ensure the home fits within the Guidelines you may need to resubmit some drawings. The DRC will then provide approval or otherwise within 10 days of the amendments.



## 2.2 Non-Conforming Designs

These Design Guidelines encourage a standard and style of home at Cadence, Ripley. The DRC understands however that you may have a different vision for your home. The DRC appreciates individuality and innovation in design and reserves the right to approve designs which may not meet the requirements of the Cadence, Ripley Home Design Guidelines but

which are considered by the DRC to be of merit. It is suggested that a concept sketch be lodged with the DRC prior to working drawings being prepared to seek feedback on designs that do not conform.



## 2.3 Construction Timelines

The timing of construction within the Cadence, Ripley community is important. Construction of your home must commence within 12 months from the date of settlement of the sale of the lot from AVJennings to the original buyer and you must not occupy your home until the home is complete. Your home should be complete and habitable within 9 months of the construction start date. Completion of your home includes all

fencing, driveway and window furnishings to windows visible from the street along with a Certificate of Classification being issued by EDQ / Ipswich City Council or your Certifier. Landscape to be complete within 3 months of completion of your home.





## 2.4 The Design Approval Process

The steps involved to obtain design approval for your home.

### Step 1



### Step 2



### Step 3



### Step 4

1. Purchase Land
2. Start planning by researching the location of services.
3. Refer to the QDC Guidelines and these Guidelines.
4. Start the design process with chosen builder / designer.



1. Ensure documents meet with the requirements of the QDC Guidelines, the Cadence, Ripley Design Guidelines and application checklist (14.0).
2. Prepare documentation for submission to the Cadence, Ripley Design Review Committee (DRC) (15.0) email: [Cadencedesign@avjennings.com.au](mailto:Cadencedesign@avjennings.com.au)
3. The DRC will assess the documentation against the Design guidelines and advise of any additional information required.
4. If your design is not approved you will need to amend it to comply with the requirements of the DRC.

1. If the requirements of the DRC are met, an approval will be issued.
2. Provide the DRC approval to your builder for them to apply for the building approval.



1. Building Approval issued from Council or your private certifier.
2. Once settlement has occurred, owners are responsible for rubbish and waste produced as part of their building process.
3. Construction of the approved plan to commence within 12 months of settlement of the land from the Seller to the original buyer. Construction to be completed within 9 months from the start date including fencing and window furnishings.
4. Landscaping to be completed within 3 months of completion of your home.
5. The new home will be inspected by the DRC during and after completion to ensure its compliance with the approved drawings.



## 2.5 Design Guidelines Compliance

### Owner Bound by Design Guidelines

The owner acknowledges that these Design Guidelines will form a legal and binding part of the contract for the lot.

The owner and Seller agree that the terms of these Design Guidelines will not merge on settlement of the contract.

### Right to Vary Design Guidelines

The Seller reserves its rights in any other sale and from time to time to vary the Design Guidelines contained herein and in that event, the owner will have no claim whatsoever against the Seller.

The Seller may in its absolute discretion vary or exclude any of these Design Guidelines from any contract for the sale of any lots in Cadence, Ripley.

### Severance

Any void, voidable or illegal term of these Design Guidelines may be severed unless to do so will result in a change to the basic nature of these Design Guidelines.

### Compliance with Design Guidelines generally

#### The buyer / owner:

- a. acknowledges that the Seller has a significant investment in Cadence, Ripley, and has an interest in maintaining the value and desirability of lots within Cadence, Ripley;
- b. acknowledges that a failure by the owner to strictly comply with the Design Guidelines will diminish the value of the Seller's significant investment in Cadence, Ripley;
- c. acknowledges that a failure by the owner to strictly comply with the Design Guidelines will diminish the value and desirability of:
  - i. unsold lots in Cadence, Ripley in the hands of the Seller; and
  - ii. lots sold by the Seller to other owners within Cadence, Ripley.
- d. agrees that in the event that the owner does not strictly comply with the Design Guidelines, the Seller will have legally enforceable rights against the owner, including the right to seek orders from the Courts compelling compliance by the owner, the right to enter onto the lot to undertake works to remedy a non-compliance and/or the right to seek damages against the owner; and
- e. hereby irrevocably grants to the Seller or the Seller's representative or agent, a licence to enter onto the lot to undertake work reasonably necessary to rectify any non compliance with the Design Guidelines, such right not to be exercised until after notice has been given by the Seller to the Design Guidelines to rectify the breach and that breach has not been rectified within the period provided for in the notice.
- f. The owner warrants and represents to the Seller that the owner will comply strictly with the terms of the Design Guidelines and that it has the capacity to do so and the owner acknowledges that the Seller has relied on and been induced by those warranties and representations, to enter into the contract with the owner to sell the lot or consent to the sale of the lot to the owner. The owner (if more than one person) agrees that they are jointly and severally liable in relation to the obligations pursuant to these Design Guidelines.



# Locating your home on your lot.

The first thing you need to do when planning your home is to decide where best to locate it on your lot.

When doing this, you need to refer to the Plan of Development table and Ipswich Planning Scheme Part 12 Division 6 and the Qld Development Code.

The Plan of Development Table may indicate the following items specifically for each stage:

- Setbacks,
- Parking and Driveways,
- Site Cover and Amenity,
- Fencing and;
- Building Design.

**NOTE: Your Builder and Certifier will provide guidance where required.**

### Site planning should also consider:

- Location of optional built to boundary walls. Consider if you would like to build up to the boundary of your property and if so, where the boundary wall can be located. These are generally on the lower side of each lot but may vary near corners and the location of infrastructure.
- Location of services and any easements

on your lot and in the road such as electricity, water, sewer and interallotment drainage, street lights, NBN Pits, storm water pits and manholes

- Orientation (refer to diagram on page 20) to maximise environmental benefits. Good orientation assists in passive heating and cooling, resulting in improved comfort and decreased energy bills. (Refer to clause 10.1)
- Eaves, awnings, hoods, screens and projected architectural elements that may extend into the setbacks or be close to the boundary.
- Disclosure plan, Plan of Development and services plan provided by developer.
- There is a maximum site coverage set within the QDC guidelines to ensure that homes include outdoor spaces.
- Where lots are under 450m<sup>2</sup> please reference table 12.6.2 in the Planning Scheme and the QDC MP 1.1
- Where lots are greater than 450m<sup>2</sup> please reference table 12.6.1 in the Planning Scheme and the QDC MP 1.2
- Driveway grades are managed under QDC NMP 1.1

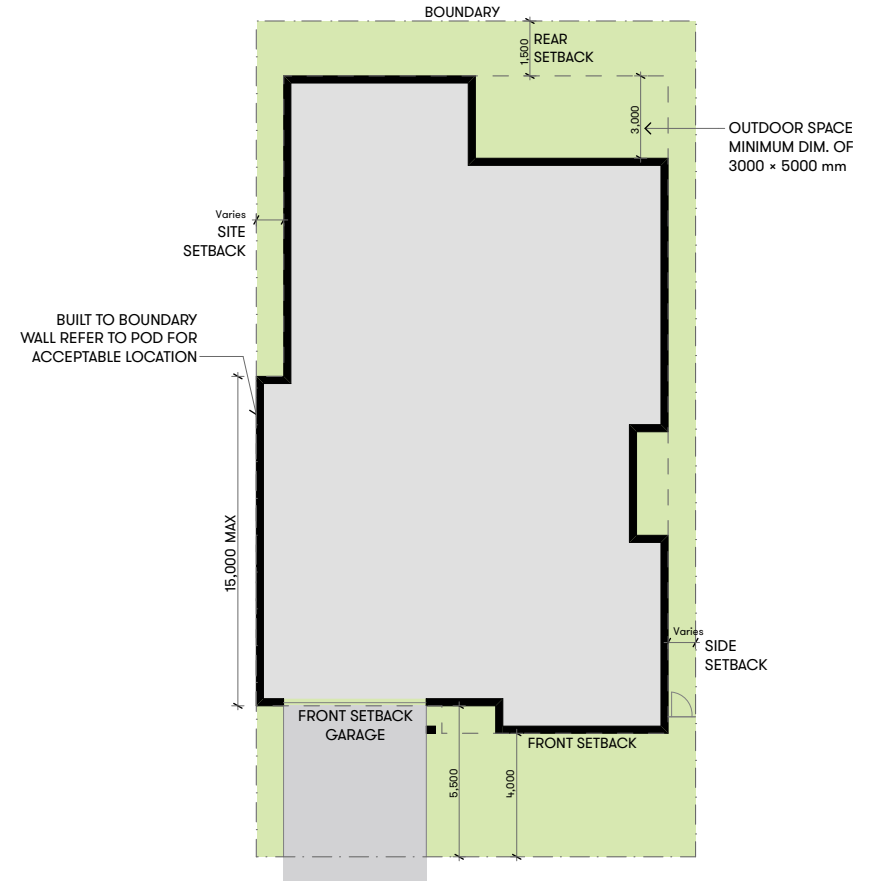

**Figure 1 - Example diagram of Lot with Setbacks**  
All dimensions in millimetres



### 3.1 **Private Open Spaces**

Private open space areas include patios and covered outdoor living areas as well as backyards.

Refer to the QDC guidelines and council policies for requirements

### 3.4 **Floor Levels**

Floor levels should be set to facilitate safe entry into the home and the garage.

**Refer to the Plan of Development for** further information on the setback requirement.

### 3.2 **Built to boundary walls**

Built to boundary walls are optional except on terrace lots where they will be required on some lots.

Reference the relevant QDC guidelines and the Plan of Development (POD) for that Stage. As a general guide, the built to boundary wall will generally be built to the lower side of your lot and have a maximum length of 15m long and have a maximum height of 4m.

### 3.5 **Bushfire Management**

Some lots within Cadence, Ripley may be impacted by Bushfire controls due to the proximity of bushland environmental corridors. Where applicable, a plan and report will be provided to you as a part of the contract.

### 3.3 **Building Heights**

Homes at Cadence, Ripley can be a maximum of two storeys. The maximum height of buildings can be 9m (as per the Plan of Development (POD), to the peak of the roof. Refer to the QDC guidelines relevant to your lot.

# Building Appearance.

Homes in Cadence, Ripley should reflect our Queensland climate and lifestyle. Classic Queensland elements such as decks, and indoor/outdoor space are encouraged.

## 4.1 Design Elements

Homes should have:

- 4.1.1 Proportions that are aesthetically pleasing.
- 4.1.2 Use of gabled roofs.
- 4.1.3 A distinctive porch / front veranda entry.
- 4.1.4 Use asymmetrical design.
- 4.1.5 Articulation (variation) in the front facade.
- 4.1.6 Use prominent windows in the front facade.
- 4.1.7 A selection of compatible facade materials, using a minimum of two material types.
- 4.1.8 A living room or bedroom window fronting the street.
- 4.1.9 Ornamentation such as glazing bars, mouldings, perforated metal panels, lace work and exterior glossy wall tiles as required.



Aesthetically pleasing proportions



Gable roofs



Distinctive porch / front entry



Assymetrical design



Variation in front facade



Prominent windows in front facade



Acceptable ornamentation



## 4.2 Building Materials and Colours

Warm, natural materials with colours that blend with the environment are encouraged for Cadence, Ripley homes.

Using a variety of materials and colours (excluding bold primary colours) that work well together will assist in creating a well-designed home. It is suggested two or up to a maximum of three different materials be used on the exterior of your home along with three different colours. The colours and materials of your home should continue around the corner of the home at least to the point where the side return fence is attached to the house

**NOTE: Use of bold primary colours is not permitted.**

**4.2.1** Materials you might choose for your home include:

- Weatherboard eg: Traditional weatherboards,
- James Hardie 'HardiePlank', James Hardie 'Linea Board'.
- Rendered or bagged and painted brick.
- Face brick, face stone eg: Traditional brick finish, Boral 'Cultured Stone'.
- Rendered blueboard or other lightweight materials.

## 4.3 Corner allotments

Corner allotments require additional attention as they have longer street frontage. It's important that homes on corner allotments:

- 4.3.1** Address design elements on both street frontages.
- 4.3.2** Include windows in the secondary street facade (or side of the home) and be of a similar size and style to windows in the front facade of your home.
- 4.3.3** The side facade should be articulated with elements such as a return verandah / entry / portico / balcony or open gable feature for interest.
- 4.3.4** Large sections of non-articulated walls are not permitted.
- 4.3.5** For two storey corner lots ensure that the ground level facade material is different to the second storey facade material to provide articulation to the overall elevation.
- 4.3.6** Fencing will require some consideration to avoid long runs of the same fence (See section 6).



5.0

# Car Parking, Garages & Driveways.

## 5.1 Car Parking

Homes must have parking for two cars per dwelling. These can be side by side in an enclosed lock up garage or in tandem where a single car garage is built.

## 5.2 Vehicle Crossovers

Only one vehicle crossover is permitted per lot in accordance with Ipswich City Council (ICC) standard for driveways and crossovers. Excludes Duplex lots.

## 5.3 Driveways

Only one driveway per lot is permitted (excluding Duplex lots). Driveways should comply with Ipswich City Council requirements. In addition:

**5.3.1** Back of kerb may be required to be saw cut / removed as per Ipswich City Council standards.

**5.3.2** Driveways should extend from the edge of the kerb to the garage /carport.

**5.3.3** To soften the surfaces of your home, provide at least 1m of screen planting between the driveway and side boundary (where possible). Please include this in your landscape plan for approval.

**5.3.4** Driveways should be constructed from materials and colours that complement the home and the landscape. Materials may include coloured concrete or exposed aggregate.

**5.3.5** Driveways should not be built over or around infrastructure services in the verge such as pits / valves. Note that if you build over or around **an NBN pit** you will have to move the pit at your own expense.

## 5.4 Garages

**5.4.1** A minimum of a single garage is required to all homes. Where a single garage is built there must be sufficient space on the driveway for a second vehicle. Homes to be designed to minimise the visual impact of the garage dominating the streetscape.

**5.4.2** Garages are not to be the closest part of the home to the street and should be setback at least 1m behind another part of the home.

**5.4.3** The garage cannot exceed 50% of the frontage of your lot. Reference the ICC Planning scheme Residential Code and QDC guidelines for details.

**5.4.4** Garages should be compatible with the main building in terms of height, walls, windows, roof forms, colours and materials.

# Fencing and Gates.

Fences make a big impact on the visual appeal of neighbourhoods. To create a friendly neighbourhood fence, designs should follow the following design criteria:

**6.0.1** Street Frontage Fence:

1. Maximum 1.2m high.
2. Minimum 50% Transparency.

**6.0.2** Fences to public open spaces such as parks:

1. Maximum 1.8m height.
2. Minimum 50% transparency.

**6.0.3** Side and Rear Fences

3. Maximum 1.8m height and pleasing to look at on both sides.
4. Side fences should not protrude in front of the house. If a safety fence is required above a retaining wall then a pool fence or similar transparent fence should be used.

**6.0.4** Gates and Side Return Fencing:

1. Must match fence construction and material.
2. Painted to match the colour scheme of your house.

**6.0.5** Fence material permitted:

1. Treated timber.
2. Composite timber material.
3. Pre-painted steel type fence such as Colorbond and Stratco.
4. Powdercoated finished aluminum batten fence.

Where the Seller has constructed a fence wholly or partly on the lot, the owner must, at the owner's sole cost:

- a. keep the fence at all times in good repair and condition; and
- b. not remove, replace or alter the fence without the prior written.

and the owner indemnifies the Seller and will keep the Seller indemnified against all loss and damage occurred by the Seller as a result or indirect result of the owners failure to comply with the obligations contained in this clause and its sub-clauses.

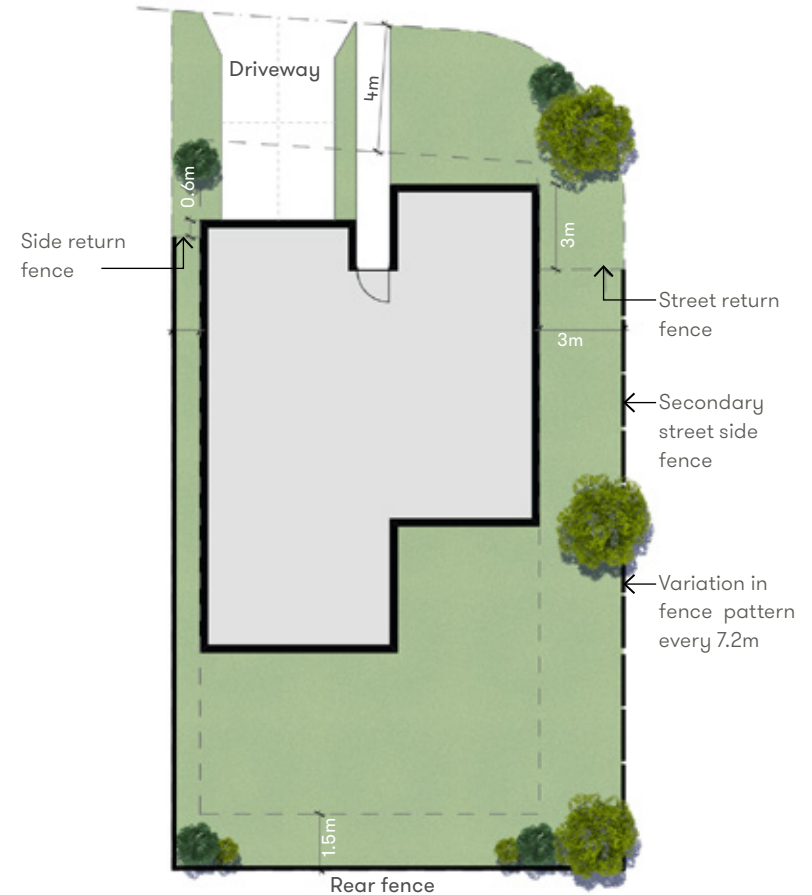

**Figure 2 - Side Fencing on Corner Lots example**  
All dimensions in metres



## 6.1 Secondary street frontage fencing

Warm, natural materials with colours that blend with the house design and or the environment are encouraged for Cadence, Ripley homes.

### Side fences, or secondary fences, on corner lots should be:

**6.1.1** A maximum of 1.8m high.

**6.1.2** Vary fence with change in fence pattern (Horizontal palings) at maximum every 8m length. The change in fence pattern to be a max of 2.1m in length.

**6.1.3** Constructed out of treated timber post and rail with treated pine paling (Refer to Fig 3 & 4)

**6.1.4** Painted to match the colour scheme of your home.

**6.1.5** A side return fence facing the street should be located between 0.6m and 3.0m back from the front facade of your home and painted to match the colour scheme of your home.

**6.1.6** The side gates in the side return fence facing the street should be of the same material as the side return fence and be 1.8m high maximum.

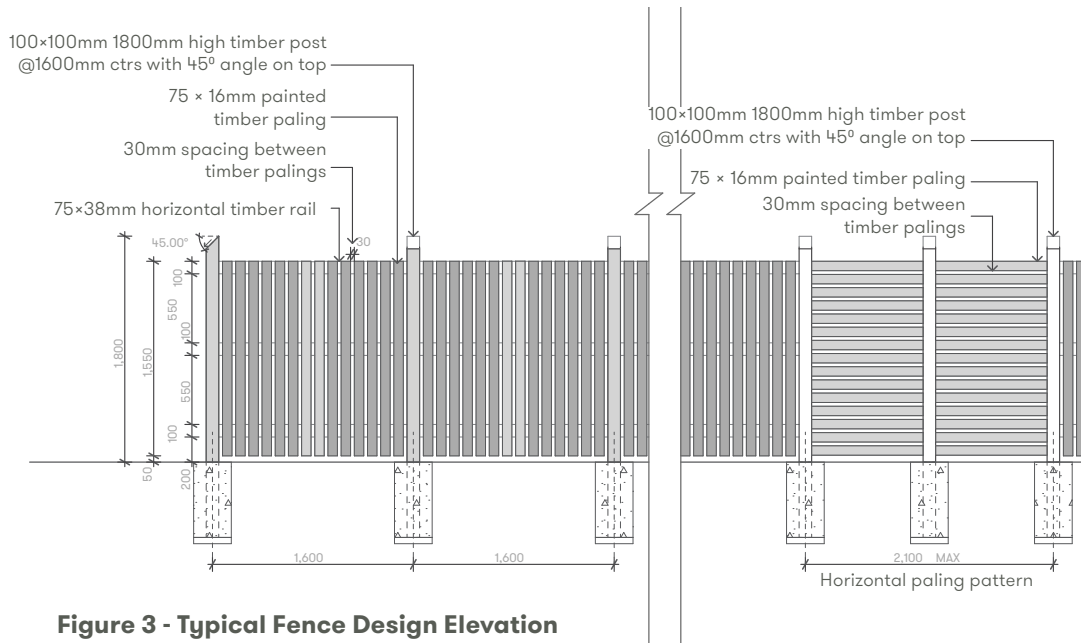

**Figure 3 - Typical Fence Design Elevation**

All dimensions in millimetres

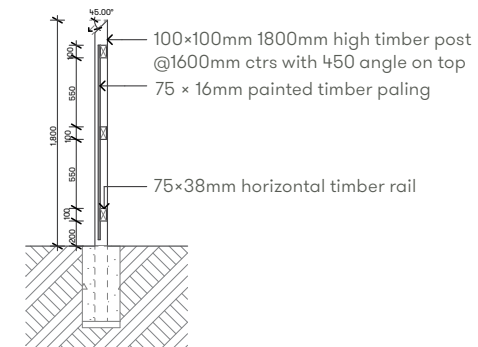

**Figure 4 - Typical Fence Detail Section**

All dimensions in millimetres

# Other Elements of Your Home.

## 7.1 Letter boxes

**Letter boxes should be pillar style (not on a pole) and complement the materials and colours used in the façade of your home.**

They should also be incorporated into the landscape and be clearly visible and identifiable from the street.

**7.1.1** Where reinforced fibre concrete pillar letter boxes are installed, provide a landscaped garden edge to prevent damage from grass trimmers.

**7.1.2** The letter box should be offset a minimum of 600mm from the edge of the driveway.

## 7.2 Entry doors

**7.2.1** The main entry door on the front façade is to be a minimum 920mm wide door. A side light must be provided if the door is less than 920mm wide.

**7.2.2** Front entrance doors must face the street

## 7.3 Curtains, Blinds and security screens

**7.3.1** For privacy and street appeal, curtains or blinds should be installed on all windows visible from the street prior to the occupation of your home. The colours should be complementary to the home's colour scheme when viewed from the outside.

**7.3.2** Security / screen doors facing the street must be black mesh screen similar to the Crimsafe® range. Diamond grill screens are not permitted on the primary street facade of the home.







## 7.4 Overhangs, Decks, Awnings & Eaves

Decks, balconies, porches, awnings and eaves are an important element of your home's design and can improve your lifestyle and provide shading to keep your home cool.

Decks and balconies should complement the style, materials and colours of the home.

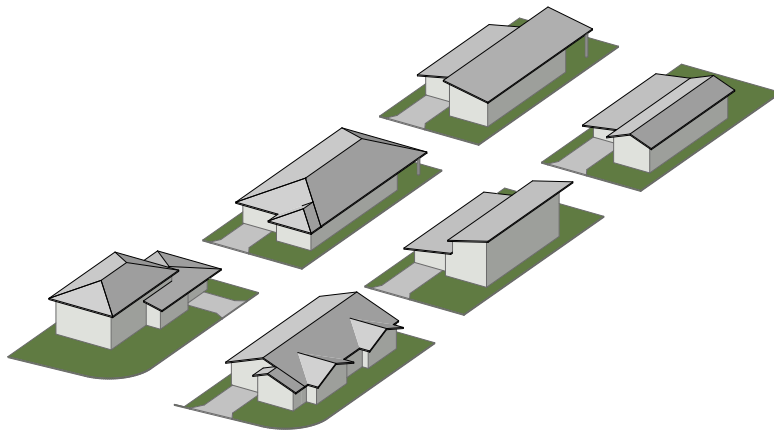

Figure 5 - Roof Type Diagrams

## 7.5 Roofs

Roof designs that are a simple composition of shapes will aid in reducing their visual prominence and improve the design and visual appeal of the home. Roof planes should be visually interesting and complement the dwelling design. The use of gables is encouraged. In addition:

**7.5.1** A break in length to the roof should be provided for fascias longer than 15m, where it is fronting a street

**7.5.2** Roof colours should be chosen to complement the home, keeping in mind that light coloured roofs keep the home cooler in summer. Natural, earthy colours are encouraged. Highly reflective and unfinished materials are not acceptable.

**7.5.3** Pitched roofs should be at a minimum of 22.5° (hip or gable)

**7.5.4** Skillion roofs should be at a minimum of 5° and max of 12°.

## 7.6 Gutters and Downpipes

Gutters and downpipes should be painted to match or complement the dwelling. Having some variation

in the roof and gutter line will improve the home's design.

## 7.7 Pools

All residential pools must meet local council requirements and all pool filters and associated

equipment must be screened from the street view.



## 8.0

# Ancillary Fixtures.

**Ancillary fixtures refer to any additional item external to the home such as air conditioning units, hot water systems and rainwater tanks.**

**8.0.1** Air-conditioning units should:

8.0.1.1 Not be visible from the street or park areas

8.0.1.2 Be located below eave lines and screened from public view

8.0.1.3 Be located to ensure that there is minimal noise impacts on neighbouring properties

8.0.1.4 Retro-fitted air-conditioners to windows which are visible from the street or public open space are not permitted.

**8.0.2** Design the location of hot water services, clotheslines, satellite dishes, rainwater tanks, spa pumps and garbage bin storage areas such that they are not visible from the street or public open space areas. Alternatively include screens that complement the materials and colours of your home to reduce the visual impact of these items.

**8.0.3** Where possible, solar hot water panels, solar panels and TV antennas should not

be placed on the front facing roof of your home and have minimal visibility from the street or public open space areas.

**8.0.4** TV antennas should have be a maximum height of 2m high at the rear of the dwelling and satellite dishes should be mounted below the ridge line of your roof or where they are not visible from the street or public open space.

**8.0.5** Ancillary and Outdoor Structures [eg. garden sheds]

8.0.5.1 Ancillary structures which impact the streetscape such as garden sheds, retaining walls, gazebos and swimming pools require approval by the DRC.

8.0.5.2 Garden Ancillary structures should be constructed from materials and colours that complement the home.

8.0.5.3 Garden sheds should be less than 10m<sup>2</sup> of non-reflective material and should be a maximum of 2.7m high and screened from public view. Building approval is required if the area of the shed is greater than 10m<sup>2</sup>.



# Duplex Lots and Secondary Dwellings.

Multiple Dwellings proposed to be constructed on a lot must be submitted to the Design Review Committee (DRC) for assessment and approval prior to any works commencing. Multiple dwellings may also be subject to further development approvals and the payment of additional charges in some instances.

The previous provisions of the covenant shall apply to the Duplex or Secondary dwellings.

Multiple dwellings must comply with the Plan of Development (POD) table, Queensland Development Code (QDC) and Economic Development Queensland (EDQ) Planning provisions.

Duplex lots may be subject to payment of additional infrastructure charges to EDQ. Each duplex lot will have dual civil servicing constructed.

The design considerations that the DRC will base their assessment on (in addition to any EDQ requirements) are as outlined below.

**Multiple dwelling lots are generally located on corner lots, lots with a frontage greater than 15 meters or rear loaded lots. Corner lot multiple dwellings must address the two street frontages. Any multiple dwelling (including secondary dwellings) must be designed so that :**

- 9.0.1** The Plan of Development (POD) setback requirements have been considered in conjunction with the QDC Code MP 1.1 & 1.2
- 9.0.2** There must be a fully formed concrete path a minimum of 1m wide with a landscape strip along the boundary fence from the street to each front door.
- 9.0.3** There should be no gate between the street frontage and the door to the secondary dwelling.
- 9.0.4** To maintain privacy for the primary / front dwelling, any side windows onto the entry path for the secondary dwelling should have a sill height of 1.7m
- 9.0.5** There should be no obstruction such as hot water systems, air-conditioning units or clothes lines between the street frontage and the door to the secondary dwelling.
- 9.0.6** There must be eaves or a covering over the path to the door of the secondary dwelling.
- 9.0.7** For rear loaded lots, there must be a door and letterbox visible to a secondary dwelling.

**Figure 6 - Secondary Dwelling example**

All dimensions in millimetres

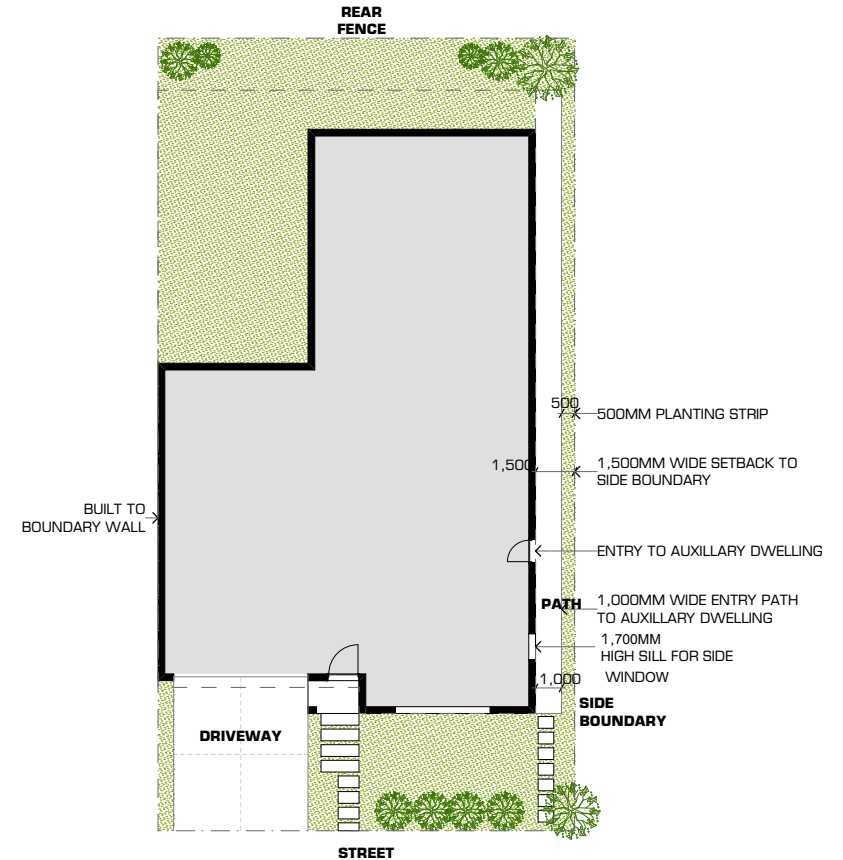

- 9.0.8** The path to the front door of the secondary dwelling must be well lit.
- 9.0.8** Two points of ventilation required to all habitable rooms for the secondary dwelling including internal and louvred windows.

# Sustainable Design.

Including sustainable design features in your home helps the environment and can also help you. Considering things like the orientation of your home can improve your comfort by making the house warmer in winter and cooler in summer.

It can also save you money in energy costs by reducing the need to heat or cool your home. Some sustainable design features you might like to consider include:



## 10.1 Energy Efficiency

The following tips and ideas may help you to achieve a more energy efficient and sustainable home:

- 10.1.1** Choosing a good orientation for your home to reduce the need for fans, air conditioning and heaters (see diagram right).
- 10.1.2** Ensuring windows are placed to encourage cross-ventilation.
- 10.1.3** Window glazing and glass treatments.
- 10.1.4** Using louvres to maximise air flow.
- 10.1.5** Use wide eaves, awnings and screening on windows for shade, particularly on western windows.
- 10.1.6** Choosing a light colour for your roof and external walls.

- 10.1.7** Using insulation in external walls and ceilings, particularly non-masonry walls.
- 10.1.8** Install energy efficient hot water systems or use solar hot water systems.
- 10.1.9** Install energy efficient appliances.
- 10.1.10** Install outdoor clothes lines.
- 10.1.11** Use energy efficient lighting such as LED and fluorescent lighting.
- 10.1.11** Use motion sensors on lighting as appropriate.
- 10.1.12** Chose construction materials to optimise sustainable outcomes.
- 10.1.13** Consider the area of prefabricated building components to minimise waste and decrease the build times.

House Orientation:

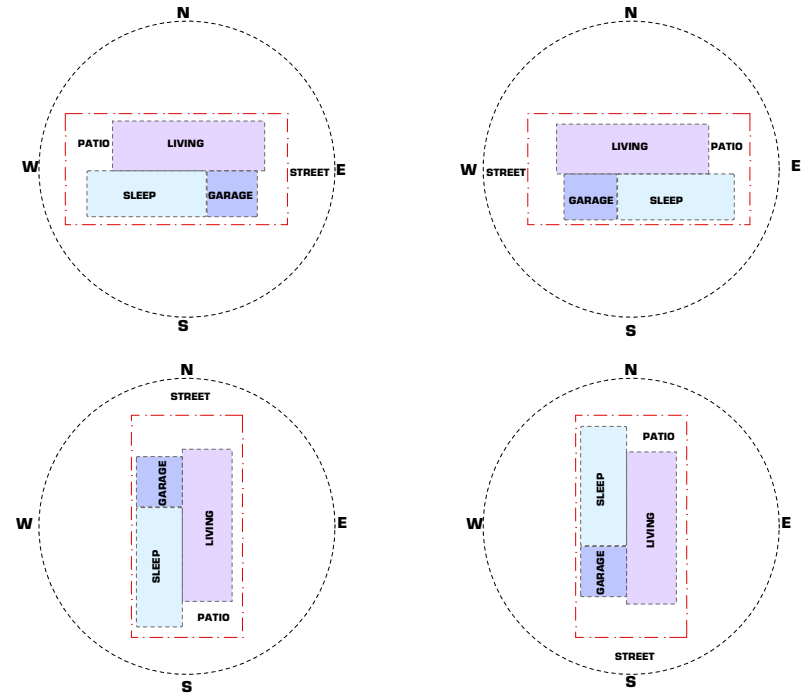



## 10.2 Water Efficiency

Some things you can do to save water and reduce your water bill include:

1. Install a rainwater tank and connect it to toilet cisterns, the laundry and external taps for car washing and watering your garden.
2. Install 4 star WELS rated fittings such as taps, shower heads and toilets as well as appliances such as dishwashers and washing machines to reduce water usage.
3. Consider the location of your hot water system to be close to the most used areas such as kitchens and bathrooms to reduce wasting water while it's heating or install two smaller systems close to uses.
4. Use drought resistant plants and ground covers where grass is not needed eg: mulch.
5. Wash cars, caravan and boats on the grass where possible.



## 10.3 Creating Healthy Homes

### Create a healthy home by:

1. Considering the types of paints, glues, plastics, and some manufactured wood products you choose when building your home. Some can release chemical substances at room temperature, called VOC's (Volatile Organic Compounds). Consider the toxicity, quantity and proximity of materials you are using.
2. Ensure cross-ventilation through good design, ceiling fans and mechanical ventilation in bathrooms.
3. Improving Site Management during construction to minimise construction waste.
4. Contain building waste in a closed receptacle.
5. Reduce potential for soil erosion by minimising site cutting and exposure to weather.
6. See also [www.yourhome.gov.au](http://www.yourhome.gov.au) and [www.nathers.gov.au](http://www.nathers.gov.au)

# Landscaping, Gardens and Yards.

The use of landscaping will vastly improve the way your home and your street looks and feels. Well designed outdoor spaces, gardens and yards for play and relaxation can improve your lifestyle.

Planting trees is encouraged for privacy, shade, texture and colour. We encourage you to plant trees that attract native birds and wildlife and for the enjoyment of future generations at Cadence, Ripley. Investing in native trees and plants that are hardy and drought tolerant will help your landscape establish quickly.

Examples of good garden design options are provided below. They include practical and environmentally sustainable outcomes. A schedule of plant species is provided for assistance in selecting recommended plants suitable for the area.

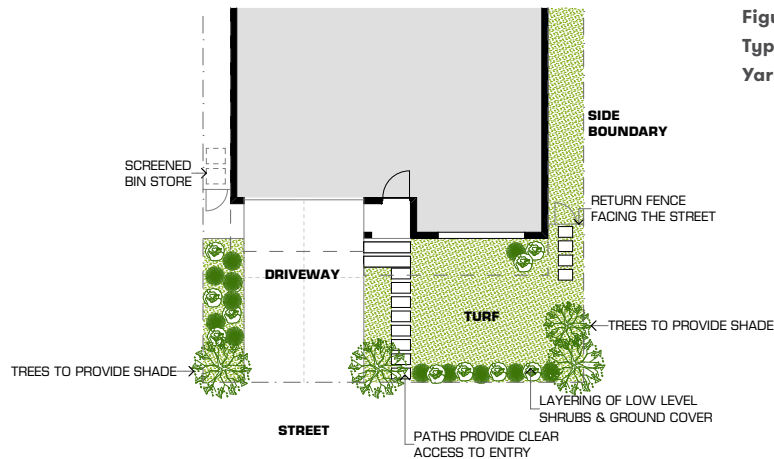

**Figure 8 - Typical Front Yard Landscape**

## 11.1 Design and Planning Considerations

### Things to consider when designing your landscaping:

1. Orientation of the gardens to consider the degree of exposure to prevailing winds and sun.
2. Soil type and depth of top soil.
3. Minimisation of water requirements – plant selections and mulching.
4. Mulching with organic materials such as pine bark or forest mulch etc will assist in maintaining ground moisture by reducing evaporation and adding nutrients to the soil.
5. Low level shrub planting between the house and street.
6. Potential shading and screening benefits of trees and plants.
7. The location of your home within Cadence, Ripley, the adjacent creek and natural surroundings.
8. Ultimate size of trees and plants when fully grown.
9. Habitat values.
10. Ensure trees are given good clearance from in-ground services and the footings of your house.



## 11.2 Retaining Walls

Some lots within Cadence, Ripley have retaining walls built by the Seller close to the boundaries to create a building pad. Where your house is on the lower side of a retaining wall you must maintain any subsoil drain from that wall and connect it into the yard drainage system for your house.

Where there is an overland flow path or roof water system at the rear of a lot, that system must be protected and the function of any continuous overland flow path must be maintained so that

water is transported from upstream properties with no damage to surrounding property. No fill is to be placed over any easement or swale drain.

**11.2.1** Any retaining wall built on your lot must be constructed in accordance with Council regulations.

**11.2.2** Retaining walls and site preparation to be completed by the builder.

**11.2.3** Timber sleeper walls and plain grey concrete sleeper walls are not permitted forward of the building line.

**11.2.4** Timber retaining walls are not recommended given their short effective service life.

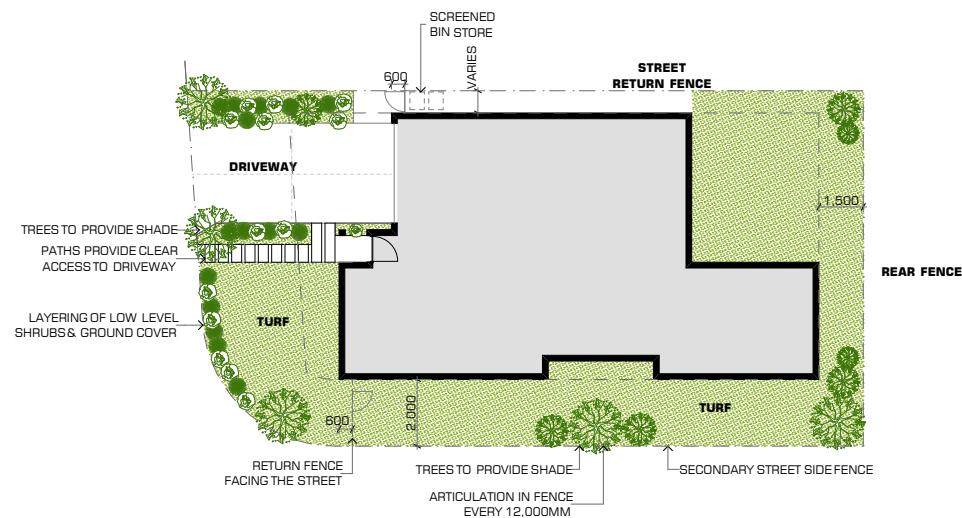

**Figure 9 - Typical Frontage Landscape for Corner Lots - Option 1**  
All dimensions in millimetres

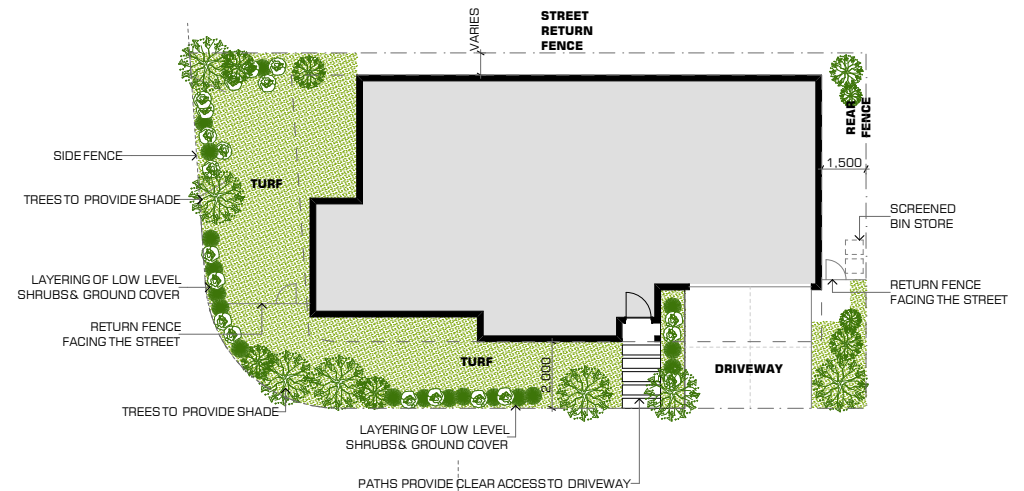

**Figure 9 - Typical Frontage Landscape for Corner Lots - Option 2**  
All dimensions in millimetres





## 10.3 Native Planting

A mix of native species in your selection creates water efficient, low nutrient gardens that also supplement surrounding habitat for local wildlife and birdlife. A landscape of shrubs and trees provides screening for privacy, shade from the extremes of the

summer sun, directs movement towards entrances and can soften the appearance of building forms from the street.



IMAGE COURTESY OF METRICON HOMES



IMAGE COURTESY OF METRICON HOMES



IMAGE COURTESY OF METRICON HOMES



IMAGE COURTESY OF METRICON HOMES

# Services at Cadence.

Cadence, Ripley is a National Broadband Network (NBN) enabled community.

1. Phone and internet services will be provided by retailers over the National Broadband Network. Connection details are available at [www.nbnco.com.au](http://www.nbnco.com.au).
2. Natural gas is available in Cadence, Ripley.
3. Free to air TV will require an antenna.



# Construction Guidelines.

**NOTE: Please make sure you and your builder are aware of the construction guidelines to ensure the safe and considerate construction of your home.**

## 13.1 Site Access

- 13.1.1** Building access to each lot during construction is to be limited to a single entry /exit point that is stabilised with gravel or similar material to protect the verge.
- 13.1.2** Any material or mud deposited on roadways must be removed daily. This is a council requirement.
- 13.1.3** Adjoining lots or park areas may not be used for construction access at any time.
- 13.1.4** Any damage to the footpaths, kerbs, roads or street landscaping must be repaired by the owner of the lot at their expense.

## 13.2 Hours of Construction

- 13.2.1** Hours of construction are Monday to Saturday 6.30 am to 6.30 pm (Ipswich City Council requirement).
- 13.2.2** No building work is allowed on Sundays or public holidays.



## 13.3 Construction Rules

- 13.3.1** All infrastructure and landscape within the verge is to be protected during construction. Any damage to trees, concrete paths, road pavements, kerbs and turf or services located in the verge is the responsibility of the owner to reinstate at their sole cost.
- 13.3.2** The owner and their builders must meet all environmental and WHS requirements of all authorities and must keep the site in a neat and tidy condition throughout the construction period including the control of sediment erosion.
- 13.3.3** No building materials or rubbish are to be left on the verge at any time during construction. No building materials or spoil are to be placed on any adjoining lot during construction.
- 13.3.4** The owner must keep and maintain all improvements constructed on the lot, all entry statements, landscaping and all lawns, trees, shrubs and gardens (whether on the lot or on any footpath adjoining the lot) in good order and condition.
- 13.3.5** If the Seller is required to expend any money in enforcing the covenants under these guidelines, then the owner acknowledges and agrees that the Seller may require the owner to reimburse the Seller for these costs (being a liquidated debt payable immediately to the Seller on demand).
- 13.3.6** All rubbish during construction is to be enclosed within a skip. The skip is to be contained within the lot.
- 13.3.7** No builder's rubbish is to be deposited on adjoining lots or on to the streetscape.
- 13.3.8** All building materials must be contained within the lot.
- 13.3.9** Materials are not to be stored on park areas, streetscapes or adjoining lots.
- 13.3.10** You must not allow rubbish to accumulate or allow excessive growth of grass or weeds upon your allotment, both before and after construction of the dwelling.
- 13.3.11** You must comply with any request by the Seller or Council to clean up an overgrown site or builder's materials.
- 13.3.12** If you fail to comply within 14 days of receiving a written notice from the Seller then you will be liable to reimburse the Seller all costs, including administration costs, incurred in the removal of such materials and repairs.
- 13.3.13** Builder's noise must be kept to a minimum. Loud music is not permitted.
- 13.3.14** Temporary toilet facilities are to be provided at each construction site.
- 13.3.15** Toilets are to be located within the boundaries of the lot.
- 13.3.16** Builders must comply with all relevant Workplace Health and Safety requirements relating to residential building construction.



**A tidy site is  
a safe site**



## 13.4 Tenants

If dwellings are tenanted, it is the lot owner's responsibility to ensure that

the lot is maintained to the required standard.

## 13.5 Vehicles

**13.5.1** You are not permitted to park unregistered vehicles in your driveway or front yard.

**13.5.2** Commercial vehicles, boats and caravans may be parked on a lot but must be screened from public view.

## 13.6 Site Clean Up

**13.3.11** You must comply with any request by the Seller or Council to clean up an overgrown site or builder's materials.

**13.3.12** If you fail to comply within 14 days of receiving a written notice from the Seller then you will be liable to reimburse the Seller all costs, including administration costs, incurred in the removal of such materials and repairs.



# Application Checklist.

Complete the application form attached to this document and send it along with drawings to the Cadence Design Review Committee.

**Email:**  
[Cadencedesign@avjennings.com.au](mailto:Cadencedesign@avjennings.com.au)

## 1.0 Site Plan

- Contours at 500mm intervals and building footprint[s] positioned on lot [1:100 / 1:200 scale] including:
- North point
- Lot size sqm
- Lot dimensions [width and depth]
- Setbacks and location of all buildings and structures
- Finished ground levels and floor levels (garage and dwelling)
- Easements
- Services [ including electricity pillar, street trees, communication pits etc]
- Shed and outdoor structure location and details. (Refer to Clause 8.1.1)
- Hot water type and location. (Refer to Clause 10.3.3.)
- Water tank location [if applicable]. (Refer to Clause 10.3.1)
- Outdoor clothes drying area.
- Site Cover payable immediately to the Seller on demand).

## Drawings Checklist

The listed below drawings need to be submitted with your application form.

## 2.0 Floor Plans [1:100 scale] Illustrating

- Internal layouts indicating location of windows, doors, stairs, built-ins, changes in level etc.
- All walls, openings etc to be dimensioned.
- Roof overhangs to be shown and dimensioned.
- Floor finishes to be indicated

## 3.0 Earthworks Plan

- Indicating extent of cut & fill (may be on site plan)

## 4.0 Roof plan [1:100 scale]

- (Refer to Clause 7.5 - 7.8 & 8.0)**
- Illustrating pitch, overhangs & setbacks
  - Materials and colours
  - Solar panels and or solar HWS locations. (Refer to Clause 8.0.7)
  - TV Aerial or satellite dish location (below the roof line). (Refer to Clause 8.0.8)



## 5.0 Retaining wall details

**(Refer to Clause 11.2)**

- Location and boundary offsets
- Levels at top and bottom
- Construction materials
- Retaining walls, driveways and fencing can also be added to the site plan and or the landscape plan.

## 6.0 Electrical Plan

- Showing all lights, power points and communication infrastructure

## 7.0 Landscape Plan

- Including all turf areas, garden beds, letter box location, clothesline and pool location (if applicable). Other pool details to include setbacks from boundary, pool pump location.

## 8.0 Fencing Plan

- Construction materials
  - Elevation
  - Heights and density
- (Refer to Clause 6.0.1 & 6.1.1 - 6.1.7)**

## 9.0 Elevations & Sections of Dwelling (1:100 scale)

- Elevations to be designated by aspect ie. N/S/E/W
  - Existing natural ground level indicated.
  - Finished ground level indicated.
  - Show elevations with true relation to actual site levels.
  - Building height
  - Materials - type & colour scheme for external walls, roofing, driveways, pathways & fencing
- (Refer to Clause 4.2 & 4.2.1 & 4.1.1 - 4.1.9)**

## 10.0 Driveway Plan and Materials

- Should show materials
- Location
- Grades
- Paths



15.0

# Building Covenant Application Form.

## Important Information

Approval must be received from the Cadence Design Review Committee for the construction of new homes,

garages, fences, landscaping and any other structures on any allotments within the Cadence community.

## 1.0 Description of Development

### Contact Details

Property Owner:

Address:

Postcode:

Home:

Work:

Mobile:

Email:

Builder /Designer:

Postcode:

Home:

Work:

Mobile:

Email:

### Site Details

Lot No:

Survey Plan Number:

Street Address:

Please complete this form and return to: [Cadencedesign@avjennings.com.au](mailto:Cadencedesign@avjennings.com.au)

## 2.0 Compliance with Relevant Documents

Council Planning Scheme Development guidelines

Cadence Home Design Guidelines

National Construction Code (Building Code of Australia)

## 3.0 Drawing Checklist

Completed design checklist (this document)

Site plan including building footprint(s) positioned on lot

National Construction Code (Building Code of Australia)

Lot size m<sup>2</sup>

Lot Dimensions (width and depth)

Setbacks (front, side and rear setbacks)

Easements

Services (electricity pillar, street trees, communications pits etc)

Electrical Plan

Roof Plan

External materials and colour selections (brick, colour render etc)

# Landscape Planting Palette.

## Suitable Plant Species

### Trees and Palms

Acmena hemilampra	Callistemon viminalis	Melaleuca linariifolia
Elaeocarpus reticulatis	Livistona australis	Ptychosperma elegans
Magnolia 'Little Gem'	Pandanus pedunculatus	Bush Satinash
Tibouchina 'Alstonville'	Xanthostemon chrysanthus	Blueberry Ash
Weeping Bottlebrush	Eumundi Ash q	Dwarf Magnolia
Cabbage Palm	Snow in Summer	Lasiandra
Pandanus	Solitaire Palm	
Golden Penda	Elaeocarpus eumundii	

### Shrubs

Acalypha 'Inferno'	Acmena smithii 'Allyn Magic'	Alpinia caerulea
Bambusa species	Banksia robur	Brunsfelsia latifolia
Callistemon 'Captain Cook'	Clerodendrum nutans	Cordyline species
Croton hybrids	Dichorisandra thrysiflora	Gardenia florida
Grevillea 'Honey Gem'	Heliconia 'Red Xmas'	Red Acalypha
Dwarf Lilly Pilly	Native Ginger	Bamboo (Clumping Types)
Swamp Banksia	Yesterday Today Tomorrow	Captain Cook Bottlebrush
Bridal Veil	Palm Lily	Crotons
Blue Ginger	Gardenia	Honey Gem
Red Christmas	Ixora hybrids	Jasminium sambac



Acmena hemilampra  
Bush Satinash



Callistemon viminalis  
Weeping Bottlebrush

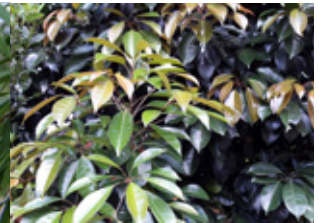

Elaeocarpus eumundii  
Eumundi Ash

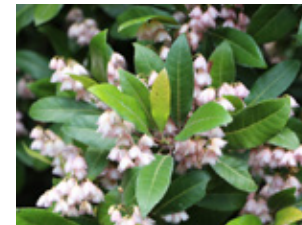

Elaeocarpus reticulatis  
Blueberry Ash



Livistona australis  
Cabbage Palm



Melaleuca linariifolia  
Snow in Summer



Xanthostemon chrysanthus  
Golden Panda



Acmena smithii 'Allyn Magic'  
Dwarf Lillypilly



Banksia robur  
Swamp Banksia

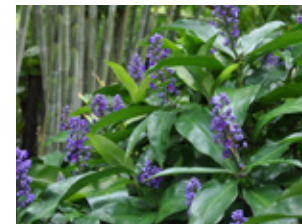

Dichorisandra thrysiflora  
Blue Ginger

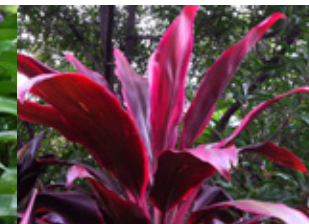

Cordyline species  
Palm Lily



Grevillea 'Honey Gem'  
Honey Gem





**Suitable Plant Species**

Hibiscus rosa-sinensis	Melastoma affine	Pittosporum revolutum
Melaleuca 'Claret Tops'	Orthosiphon aristatus	Strelitzia reginae
Mussaenda 'Aureora'	Raphis excelsa	Westringia fruticosa
Plumbago auriculata	Tibouchina Jules	Yellow Ixora
Syzygium hybrids	Rose of China	Native Lasiandra
Asplenium australasicum	Dwarf Paperbark	Cats Whiskers
Arabian Jasmine	White Mussaenda	Raphis Palm
Fiji Christmas Bush	Blue Blue Jasmine	Dwarf Lasiandra
Brisbane Laurel	Lillypillies	
Bird of Paradise	Crows Nest Fern	
Coastal Rosemary	Metrosideros 'Fiji Fire'	

**Grasses and Groundcovers**

Cissus 'Ellen Danica'	Curculigo capitulata	Gardenia radicans
Goodenia ovata	Grevillea 'Royal Mantle'	Hemerocallis hybrids
Hymenocallis littoralis	Liriope species	Lomandra hystrix
Myoporum ellipticum	Neoregellia compacta	Pratia pedunculata blue
Scaevola "Purple Fanfare"	Viola hederacea	Water Vine
Palm Grass	Prostrate Gardenia	Prostrate Hop Goodenia
Royal Mantle	Day Lillies	Spider Lily
Strippy White, Evergreen Giant	Slender Mat Rush	Coastal Myoporum
Compact Bromeliade	Blue Matted Pratia	Fan Flower

**Suitable Varieties of Turf**

For Sunny Areas -	Green Couch - eg. 'Wintergreen', Greenlees Park' or 'Legend'
For shaded Areas	Zoyzia - eg. 'Empire' low mow variety For Shaded Areas - Buffalo - 'Sir Walter', 'Sapphire'



Viola hederacea  
Native Violet

Strelitzia reginae  
Bird of Paradise

Westringia fruticosa  
Coastal Rosemary



Asplenium australasicum  
Crows Nest Fern

Hymenocallis littoralis  
Spider Lilly

Lomandra hystrix  
Slender Mat Rush

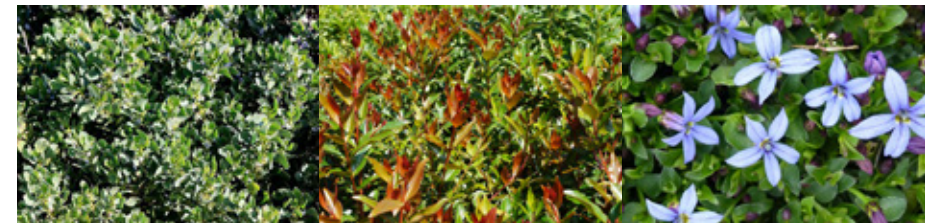

Myoporum ellipticum  
Coastal Myoporum

Metrosideros 'Fiji Fire'  
Fiji Christmas Bush

Pratia pedunculata Blue  
Blue Matted Pratia

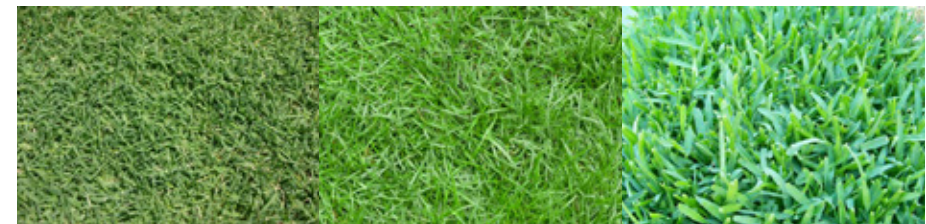

Green Couch - 'Wintergreen'

Zoyzia - low mow variety

Buffalo - 'Sir Walter'

# Disclaimer.

The Seller reserves the right to not approve any house design and the right to approve non-conforming designs that would not otherwise require statutory approval.

The Seller also reserves the right to vary the requirements of the Home Design Guidelines subject to Council Approval.

Unless otherwise indicated, where a relaxation or variation is granted, it is for a specific lot and is not to be taken as a variation to the Home Design Guidelines as a whole.

Any approval granted by the Seller/ Developer under these Home Design Guidelines is concerned only with the style, appearance and suitability to the Development of the proposed improvements and is not intended to warrant or guarantee the soundness, structural or otherwise, of any proposal to construct improvements on the Land, submitted to the Seller/Developer by the Buyer.

The Buyer should seek expert advice with respect to the soundness, structural or otherwise, of any proposal for the construction of improvements on the Land.

The Seller/Developer shall not, in any circumstances, be liable for any damage or loss (including direct, indirect and consequential damage or loss), caused to the Buyer through the negligent construction of improvements on the Land.

The Seller/Developer's Home Design Guidelines enforcement responsibility will terminate 3 months following the sale of the final allotment within Seller / Developer's Estate.

The Home Design Guidelines as prepared by the Seller ceases to apply at the time that the Seller/Developer's Home Design Guidelines enforcement responsibilities are terminated.

**Disclaimer:**

This document and all the content within forms part of the contract for properties in Cadence, Ripley. Illustrations, photos, maps and plans are indicative only and may not be to scale. It is recommended that prospective purchasers undertake their own enquiries for their own benefit and seek independent advice before entering into any agreement of any nature with any party.

「  
**Your  
community  
developer.**